

The ABC of EMG

A Practical Introduction
to Kinesiological Electromyography

Peter Konrad
Version 1.0 April 2005

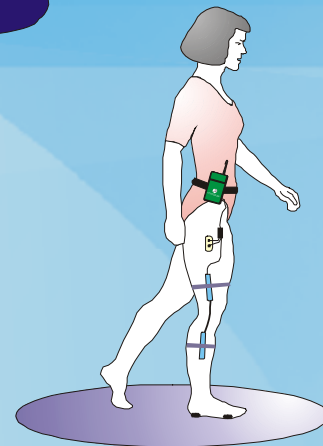
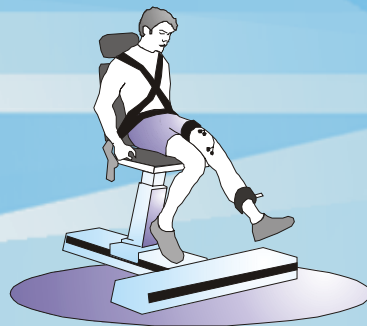
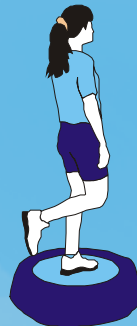
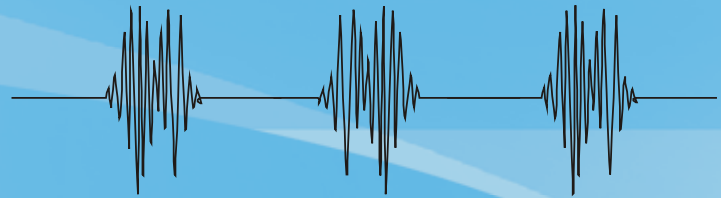
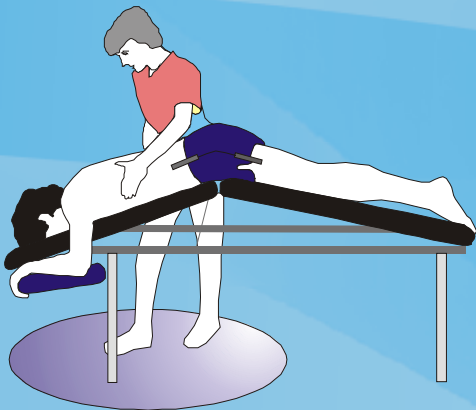

Powered by:

 **Noraxon INC. USA.**

Contents:

SIGNAL ORIGIN AND ACQUISITION

INTRODUCTION & DEFINITION	4
USE AND BENEFITS OF EMG	5
SIGNAL ORIGIN 1	6
THE GENERATION OF THE EMG SIGNAL	7
SIGNAL PROPAGATION AND DETECTION	8
COMPOSITION OF EMG SIGNAL	9
NATURE THE OF EMG SIGNAL	10
THE INFLUENCE OF DETECTION CONDITION	11
EMG AMPLIFICATION	12
COMPUTATION OF THE EMG SIGNAL	13
SKIN PREPARATION	14
SURFACE ELECTRODE SELECTION	15
FINE WIRE ELECTRODES	16
GUIDELINES ELECTRODE APPLICATION	17
SPECIFIC ASPECTS OF ELECTRODE APPLICATION	18
MUSCLE MAP FRONTAL	19
MUSCLE MAP DORSAL	20
SIGNAL CHECK PROCEDURES	21
SIGNAL CHECK PROCEDURES	22
SIGNAL CHECK PROCEDURES	23
EMG ARTIFACTS	24
PREPARE EMG - ACTION LIST	25

SIGNAL PROCESSING

SIGNAL PROCESSING - RECTIFICATION	26
SIGNAL PROCESSING - SMOOTHING	27
SIGNAL PROCESSING - DIGITAL FILTERING	28
SIGNAL PROCESSING – AMPLITUDE NORMALIZATION	29
SIGNAL PROCESSING – ECG REDUCTION	35
TIME NORMALIZATION FOR REPETITION CYCLES	36
AVERAGE EMG / ENSEMBLE AVERAGES	37
EMG AMPLITUDE PARAMETERS	39
EMG FREQUENCY PARAMETERS	40
TIMING RELATED PARAMETERS	41
THRESHOLDS CONCEPTS TO DEFINE SUBPERIODS	42
EMG TO FORCE RATIO	43

EMG ANALYSIS

<u>EMG AS A BIOMECHANICAL METHOD</u>	44
<u>EMG ANALYSIS QUESTIONS - OVERVIEW</u>	45
<u>EMG ANALYSIS: ON/OFF?</u>	46
<u>EMG ANALYSIS: MORE / LESS?</u>	47
<u>EMG ANALYSIS: MUSCLE TIMING?</u>	48
<u>EMG ANALYSIS: HOW MUCH ACTIVITY?</u>	49
<u>EMG ANALYSIS: HOW MUCH FATIGUE?</u>	50
<u>EMG ANALYSIS: MOVEMENT COORDINATION</u>	51
<u>DESIGN OF EMG TESTS: NEED OF STANDARDIZATION</u>	52
<u>RECOMMENDATIONS FOR TEST STANDARDIZATION</u>	53
<u>EMG TRIGGERED TO MOVEMENT</u>	54
<u>PERIOD DEFINITION FOR ANALYSIS</u>	55
<u>COMPARISON ANALYSIS</u>	56
<u>RECOMMENDED EMG BOOKS</u>	57
<u>EMG GUIDELINES, SOCIETIES, SEARCH LINKS</u>	58

Introduction & Definition

How to use this booklet

This first edition of "The ABC of EMG" is primarily a short **teaching manual** concerned with recapitulating selected scientific concepts as well as general contents and processes of the experimental technique. This booklet is not intended to replace the fundamental EMG literature (see chapter "Recommended EMG Books", which is also used as reference source for citations), especially when concerned with more experience leading to an increased complexity of the problems tackled.

The **main intention** is to simplify the first steps in the use of EMG as research and evaluation tool and "get started". It tries to overview and summarize the basic knowledge needed to apply and perform meaningful EMG setups and concentrates on practical questions and solutions.

It is strongly recommended to study the scientific publications and textbooks related to a certain topic. This booklet cannot reflect the variety of different views, opinions and strategies that have to be considered for a **responsible scientific use of EMG**.

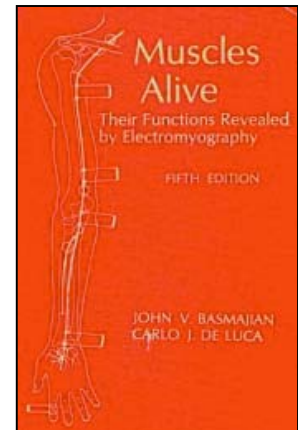
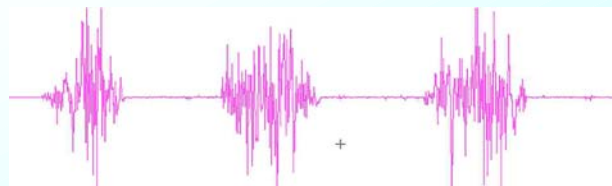

Fig. 1: A fundamental EMG text book. Basmajian & DeLuca: **Muscles Alive** (2)

Definition of EMG

"**Electromyography** (EMG) is an experimental technique concerned with the development, recording and analysis of myoelectric signals. Myoelectric signals are formed by physiological variations in the state of muscle fiber membranes." (2).

Electromyography...



"..is the study of muscle function through the inquiry of the electrical signal the muscles emanate."

Fig. 2: Basmajian & DeLuca: Definition **Muscles Alive** (2 - p. 1)

Unlike the classical **Neurological EMG**, where an artificial muscle response due to external electrical stimulation is analyzed in static conditions, the focus of **Kinesiological EMG** can be described as the study of the neuromuscular activation of muscles within postural tasks, functional movements, work conditions and treatment/training regimes.

Use and Benefits of EMG

Wide spread use of EMG

Besides basic physiological and biomechanical studies, kinesiological EMG is established as an **evaluation tool** for applied research, physiotherapy/rehabilitation, sports training and interactions of the human body to industrial products and work conditions:

Medical Research

- Orthopedic
- Surgery
- Functional Neurology
- Gait & Posture Analysis

Rehabilitation

- Post surgery/accident
- Neurological Rehabilitation
- Physical Therapy
- Active Training Therapy

Ergonomics

- Analysis of demand
- Risk Prevention
- Ergonomics Design
- Product Certification

Sports Science

- Biomechanics
- Movement Analysis
- Athletes Strength Training
- Sports Rehabilitation



Fig.3: Application areas of kinesiological EMG

Typical benefits of EMG

The use of EMG starts with the basic question: “What are the muscles doing?”

Typical **benefits** are:

- EMG allows to directly “look” into the muscle
- It allows measurement of muscular performance
- Helps in decision making both before/after surgery
- Documents treatment and training regimes
- Helps patients to “find” and train their muscles
- Allows analysis to improve sports activities
- Detects muscle response in ergonomic studies



Fig. 4: Direct look into the body / muscle function: EMG synchronized with video and other movement sensors. Software screenshot of MyoResearch XP™ - NORAXON INC. USA

Signal Origin 1

The Motor Unit

The smallest functional unit to describe the neural control of the muscular contraction process is called a **Motor Unit** (Fig. 5). It is defined as "...the cell body and dendrites of a motor neuron, the multiple branches of its axon, and the muscle fibers that innervates it (5, p. 151). The term *units* outlines the behavior, that all muscle fibers of a given motor unit act "**as one**" within the innervation process.

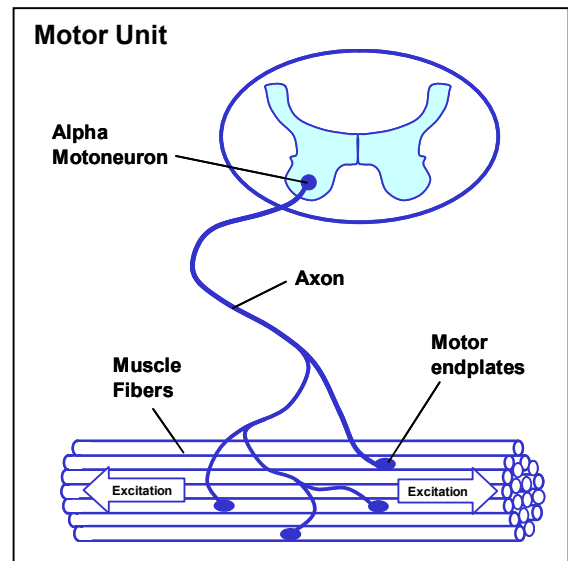

Fig.5: Motor unit. Adopted & modified from 2,7

Excitability of muscle membranes

The excitability of muscle fibers through neural control represents a major factor in muscle physiology. This phenomenon can be explained by a model of a **semi-permeable membrane** describing the electrical properties of the sarcolemma. An ionic equilibrium between the inner and outer spaces of a muscle cell forms a **resting potential** at the muscle fiber membrane (approximately -80 to -90 mV when not contracted). This difference in potential which is maintained by physiological processes (**ion pump**) results in a negative intracellular charge compared to the external surface. The activation of an alpha-motor anterior horn cell (induced by the central nervous system or reflex) results in the conduction of the excitation along the motor nerve. After the release of transmitter substances at the motor endplates, an endplate potential is formed at the muscle fiber innervated by this motor unit. The diffusion characteristics of the muscle fiber membrane are briefly modified and Na^+ ions flow in. This causes a membrane **Depolarization** which is immediately restored by backward exchange of ions within the active ion pump mechanism, the **Repolarization**:

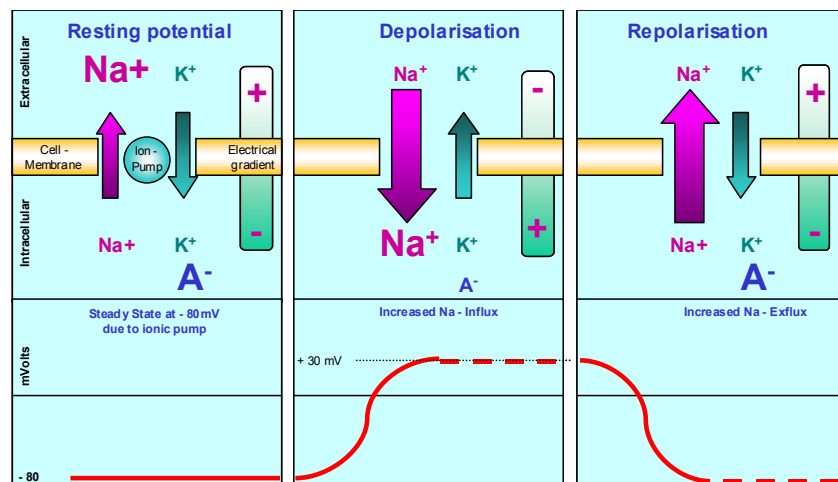

Fig.6: Schematic illustration of depolarization / repolarization cycle within excitable membranes

The Generation of the EMG Signal

The Action Potential

If a certain threshold level is exceeded within the Na⁺ influx, the depolarization of the membrane causes an **Action potential** to quickly change from - 80 mV up to + 30 mV (Fig. 7). It is a monopolar electrical burst that is immediately restored by the repolarization phase and followed by an **After Hyperpolarization** period of the membrane. Starting from the motor end plates, the action potential spreads along the muscle fiber in both directions and inside the muscle fiber through a tubular system.

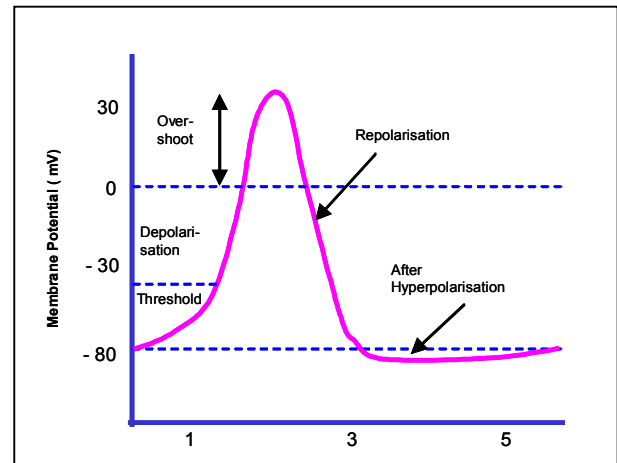

Fig.7: The Action Potential. Adopted & redrawn from 5, p. 164

This excitation leads to the release of calcium ions in the intra-cellular space. Linked chemical processes (**Electro-mechanical coupling**) finally produce a shortening of the contractile elements of the muscle cell.

This model linking excitation and contraction represents a highly correlated relationship (although weak excitations can exist that do not result in contraction). From a practical point of view, one can assume that in a healthy muscle any form of muscle contraction is accompanied by the described mechanisms.

The EMG - signal is based upon action potentials at the muscle fiber membrane resulting from depolarization and repolarization processes as described above. The extent of this **Depolarization zone** (Fig. 8) is described in the literature as approximately 1-3mm² (11). After initial excitation this zone travels along the muscle fiber at a velocity of 2-6m/s and passes the electrode side:

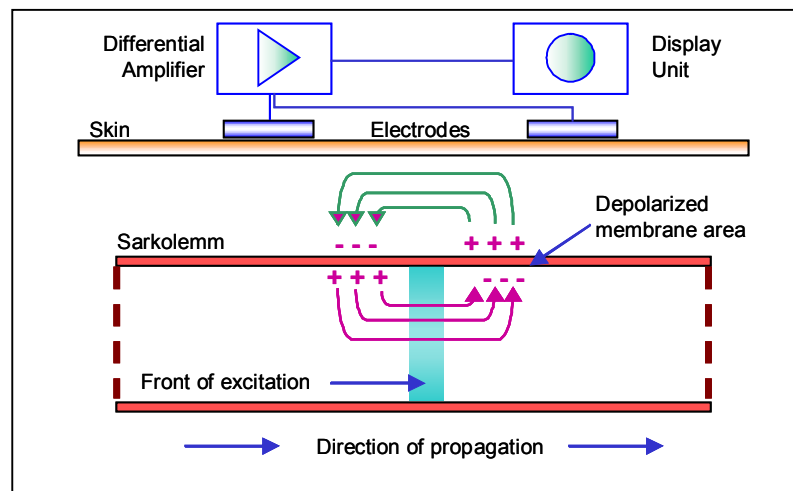

Fig.8: The depolarisation zone on muscle fiber membranes. Adopted & modified from 7, p. 73)

Signal Propagation and Detection

An electrical model for the motor action potential

The depolarization – repolarization cycle forms a depolarization wave or **electrical dipole** (11) which travels along the surface of a muscle fiber. Typically bipolar electrode configurations and a differential amplification are used for kinesiological EMG measures. For simplicity, in a first step, only the detection of a single muscle fiber is illustrated in the following scheme. Depending on the spatial distance between electrodes 1 and 2 the dipole forms a potential difference between the electrodes.

In the example illustrated in figure 9, at time point **T1** the action potential is generated and travels towards the electrode pair. An increasing potential difference is measured between the electrodes which is highest at position **T2**. If the dipole reaches an equal distance between the electrodes the potential difference passes the zero line and becomes highest at position **T4**, which means the shortest distance to electrode 2.

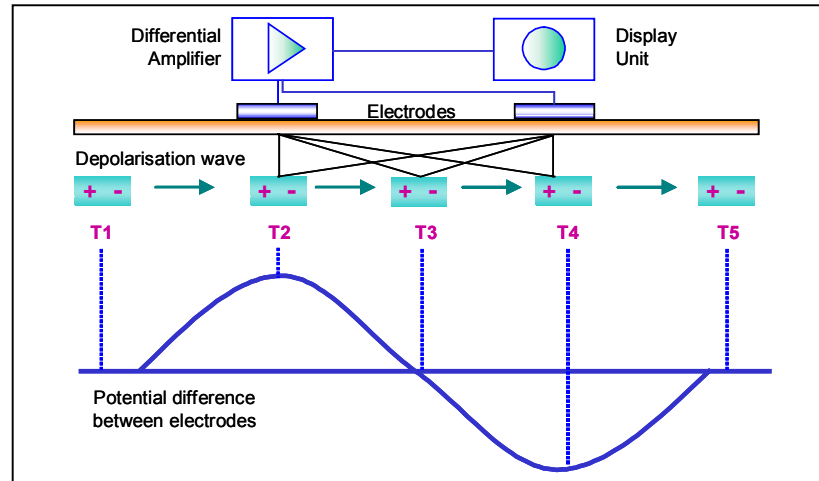

Fig.9: The model of a wandering electrical dipole on muscle fiber membranes. Adopted & modified from 7, p. 73

This model explains why the monopolar action potential creates a bipolar signal within the differential amplification process. Because a motor unit consists of many muscle fibers, the electrode pair “sees” the magnitude of all innervated fibers within this motor unit - depending on their spatial distance and resolution. Typically, they sum up to a triphasic **Motor unit action potential (“MUAP” - 2)**, which differs in form and size depending on the geometrical fiber orientation in ratio to the electrode site (Fig. 10):

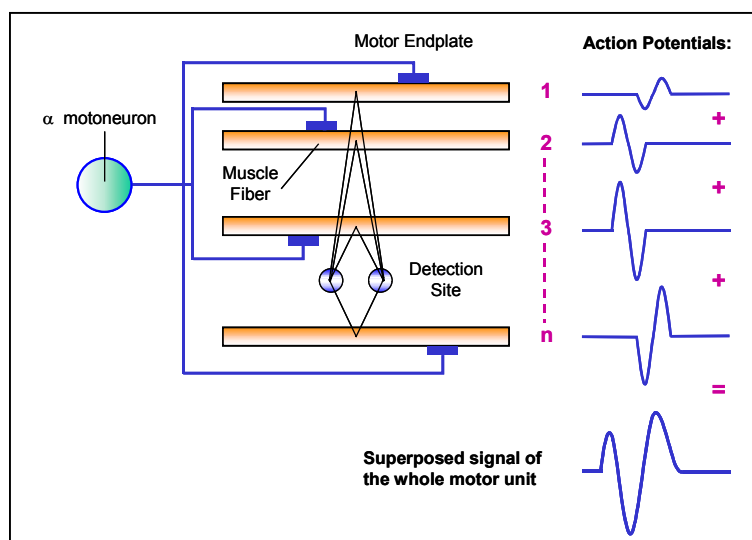

Fig.10: Generation of the triphasic motor unit action potential. Adopted & modified from 2, p. 68

Composition of EMG Signal

Superposition of MUAPs

Within kinesiological studies the motor unit action potentials of all active motor units detectable under the electrode site are electrically **superposed** (Fig. 11) and observed as a bipolar signal with symmetric distribution of positive and negative amplitudes (mean value equals to zero). It is called an **Interference pattern**.

Recruitment and Firing Frequency

The two most important mechanisms influencing the magnitude and density of the observed signal are the **Recruitment** of MUAPs and their **Firing Frequency**.

These are the **main control strategies** to adjust the contraction process and **modulate the force output** of the involved muscle. Because the human connective tissue and skin layers have a low pass filter effect on the original signal, the analyzed firing frequency e.g. of a surface EMG does not present the original firing and amplitude characteristics. For simplicity, one can say that the EMG signal directly reflects the recruitment and firing characteristics of the detected motor units within the measured muscle (Fig. 12):

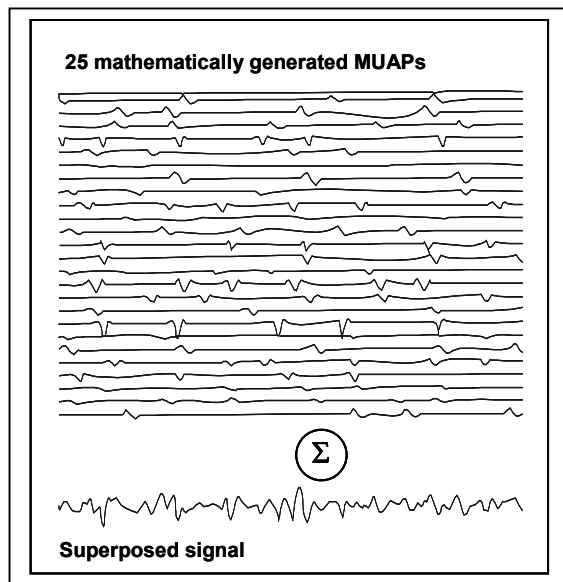

Fig. 11: Superposition of MUAPs to a resulting electromyogram. Adopted & modified from 2, p. 81

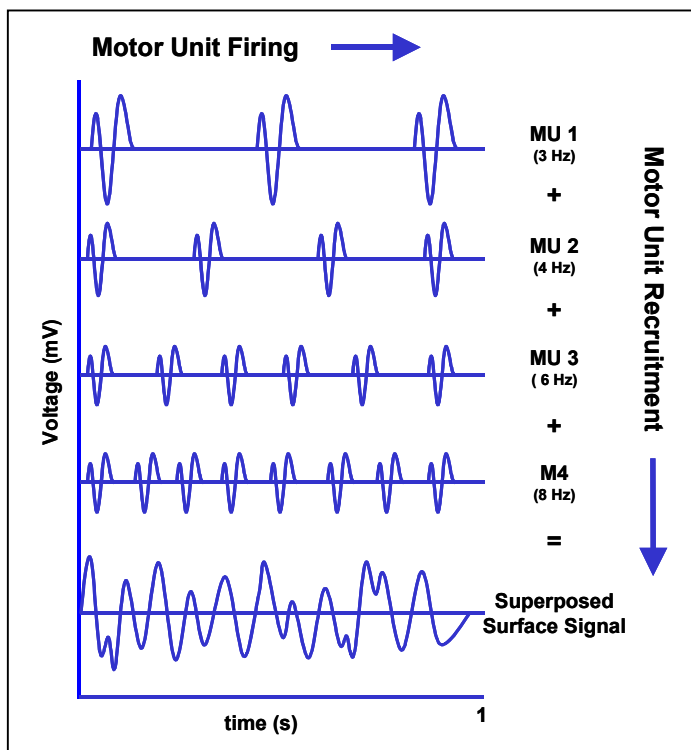

Fig. 12: Recruitment and firing frequency of motor units modulates force output and is reflected in the superposed EMG signal. Adopted & modified from 7, p. 75

Nature the of EMG Signal

The “raw” EMG signal

An unfiltered (exception: amplifier bandpass) and unprocessed signal detecting the superposed MUAPs is called a **raw EMG Signal**. In the example given below (Fig. 13), a raw surface EMG recording (sEMG) was done for three static contractions of the biceps brachii muscle:

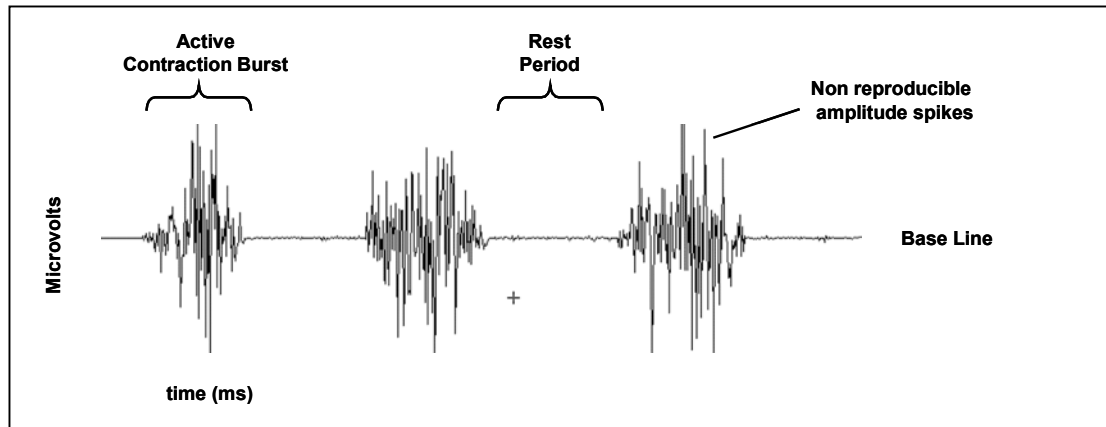

Fig.13: The raw EMG recording of 3 contractions bursts of the *M. biceps br.*

When the muscle is relaxed, a more or less noise-free EMG **Baseline** can be seen. The raw EMG baseline noise depends on many factors, especially the quality of the EMG amplifier, the environment noise and the quality of the given detection condition. Assuming a state-of-the-art amplifier performance and proper skin preparation (see the following chapters), the averaged baseline noise should not be higher than 3 – 5 microvolts, 1 to 2 should be the target. The investigation of the EMG baseline quality is a very important checkpoint of every EMG measurement. Be careful not to interpret interfering noise or problems within the detection apparatus as “increased” base activity or muscle (hyper-) tonus!

The healthy relaxed muscle shows no significant EMG activity due to lack of depolarization and action potentials! By its nature, raw EMG spikes are of **random shape**, which means one raw recording burst cannot be precisely reproduced in exact shape. This is due to the fact that the actual set of recruited motor units constantly changes within the matrix/diameter of available motor units: If occasionally two or more motor units fire at the same time and they are located near the electrodes, they produce a strong superposition spike! By applying a smoothing algorithm (e.g. moving average) or selecting a proper amplitude parameter (e.g. area under the rectified curve), the **non-reproducible contents** of the signal is eliminated or at least minimized.

Raw sEMG can **range** between +/- 5000 microvolts (athletes!) and typically **the frequency contents** ranges between 6 and 500 Hz, showing most frequency power between ~ 20 and 150 Hz (see chapter Signal Check Procedures)

The Influence of detection condition

Factors influencing the EMG signal

On its way from the muscle membrane up to the electrodes, the EMG signal can be influenced by several external factors altering its shape and characteristics. They can basically be grouped in:

1) Tissue characteristics

The human body is a good electrical conductor, but unfortunately the electrical conductivity varies with **tissue type**, thickness (Fig. 14), physiological changes and temperature. These conditions can greatly vary from subject to subject (and even within subject) and prohibit a direct quantitative comparison of EMG amplitude parameters calculated on the unprocessed EMG signal.

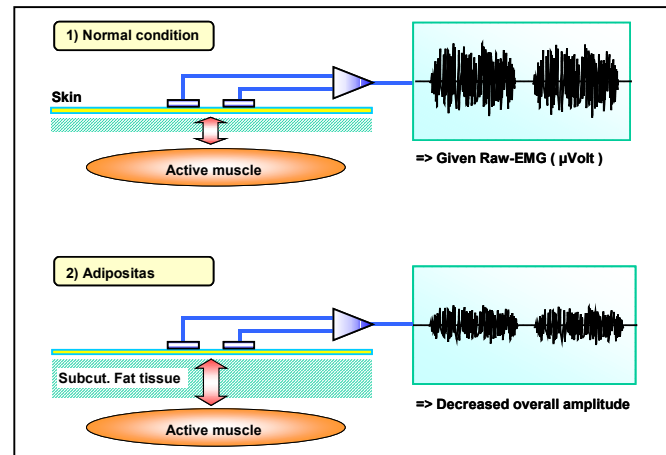

Fig. 14: The influence of varying thickness of tissue layers below the electrodes: Given the same amount of muscle electricity condition 1 produces more EMG magnitude due to smaller distance between muscle and electrodes

2) Physiological cross talk

Neighboring muscles may produce a significant amount of EMG that is detected by the local electrode site. Typically this “**Cross Talk**” does not exceed 10%-15% of the overall signal contents or isn’t available at all. However, care must be taken for narrow arrangements within muscle groups.

ECG spikes can interfere with the EMG recording, especially when performed on the upper trunk / shoulder muscles. They are easy to see and new algorithms are developed to eliminate them (see ECG Reduction).

3) Changes in the geometry between muscle belly and electrode site

Any change of distance between signal origin and detection site will alter the EMG reading. It is an inherent problem of all dynamic movement studies and can also be caused by external pressure.

4) External noise

Special care must be taken in very noisy electrical environments. The most demanding is the direct interference of power hum, typically produced by incorrect grounding of other external devices.

5) Electrode and amplifiers

The selection/quality of electrodes and internal amplifier noise may add signal contents to the EMG baseline. Internal amplifier noise should not exceed 5 Vrms (ISEK Standards, see chapter “Guidelines...”)

Most of these factors can be minimized or controlled by accurate preparation and checking the given room/laboratory conditions.

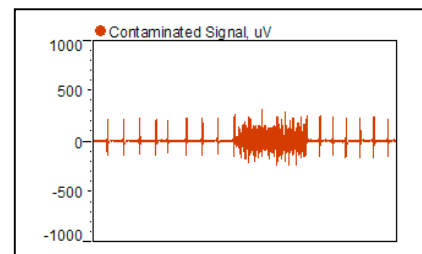

Fig. 15: Raw EMG recording with heavy ECG interference

EMG Amplification

EMG - Amplifiers

EMG-amplifiers act as differential amplifiers and their main quality item is the ability to reject or eliminate artifacts. The differential amplification detects the potential differences between the electrodes and cancels external interferences out. Typically external noise signals reach both electrodes with no phase shift. These “common mode” signals are signals equal in phase and amplitude. The term "common mode gain" refers to the input-output relationship of common mode signals. The "**Common Mode Rejection Ratio**" (**CMRR**) represents the relationship between differential and common mode gain and is therefore a criteria for the quality of the chosen amplification technique. The CMRR should be as high as possible because the elimination of interfering signals plays a major role in quality. A value >95dB is regarded as acceptable (11, SENIAM, ISEK).

State of the art concepts prefer the use of **EMG pre-amplifiers**. These miniaturized amplifiers are typically built-in the cables or positioned on top of the electrodes (**Active electrodes**). The latter pre-amplifier type can have the disadvantage of a bulky electrode detection side with increased risk of pressure artifacts (e.g. when sitting on them) and they typically do not allow free selection of electrode types. The main idea of using small EMG pre-amplifiers located near the detection site is early pick up of the signal, amplify it (e.g. 500 gain) and transmit it on a low Ohm level that is less sensitive to (cable-) movement artifacts.

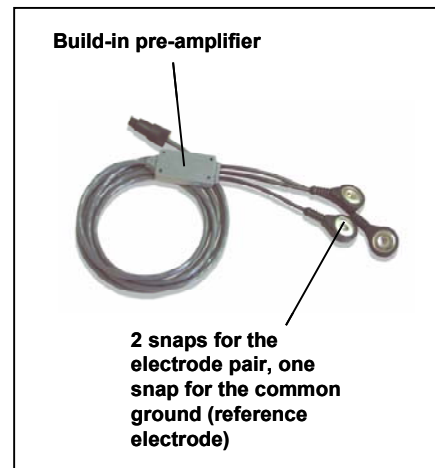

Fig.16: Electrode leads with cable built-in pre-amplifiers System NORAXON INC USA



Fig.17: Variety of EMG amplifiers ranging from 1 or 2 channel Biofeedback units to tethered and telemetric systems. Systems by NORAXON INC. USA

The un-amplified EMG signal on the skin has typical charges between a few microvolt and 2-3 millivolt. The signal is generally amplified by a factor of at least 500 (e.g. when using pre-amplifiers) to 1000 (passive cable units). The **Input impedance** of the amplifier should have a value of at least 10x the given impedance of the electrode. Winter (11) suggests an input impedance of 1-10 **MegaOhm**. The **frequency range** of an EMG amplifier (bandpass settings) should start from 10 Hz highpass and go up to 500 Hz lowpass. Any **Notch filtering** (to cancel e.g. power hum) needs to be avoided because it destroys too much signal information (SENIAM, ISEK). Both cable and telemetry systems are available and applied concepts range from handheld 1or 2 channel - **Biofeedback units** up to **32 channel systems** for complex and multi-parametric setups (Fig. 17).

Computation of the EMG signal

A/D Resolution

Before a signal can be displayed and analyzed in the computer, it has to be converted from an analog voltage to a digital signal (A/D conversion). The **resolution** of A/D measurement boards have to properly convert the expected amplitude range (e.g. +/- 5 Volts). A 12 bit A/D board can separate the voltage range of the input signal into 4095 intervals ($2^{12}=4096$ levels =4095 intervals). This is sufficient for most kinesiological setups. Very small signals may need a higher amplification to achieve a better amplitude resolution.

A/D Sampling Rate

The other important technical item is the selection of a proper **Sampling Frequency**. In order to accurately “translate” the complete frequency spectrum of a signal, the sampling rate at which the A/D board determines the voltage of the input signal must be at least twice as high as the maximum expected frequency of the signal. This relationship is described by the **sampling theorem of Nyquist**: sampling a signal at a frequency which is too low results in **aliasing effects** (Fig. 18). For EMG almost all of the signal power is located between 10 and 250 Hz and scientific recommendations (SENIAM, ISEK) require an amplifier band setting of 10 to 500 Hz. This would result in a sampling frequency of at least **1000 Hz** (double band of EMG) or even 1500 Hz to avoid signal loss.

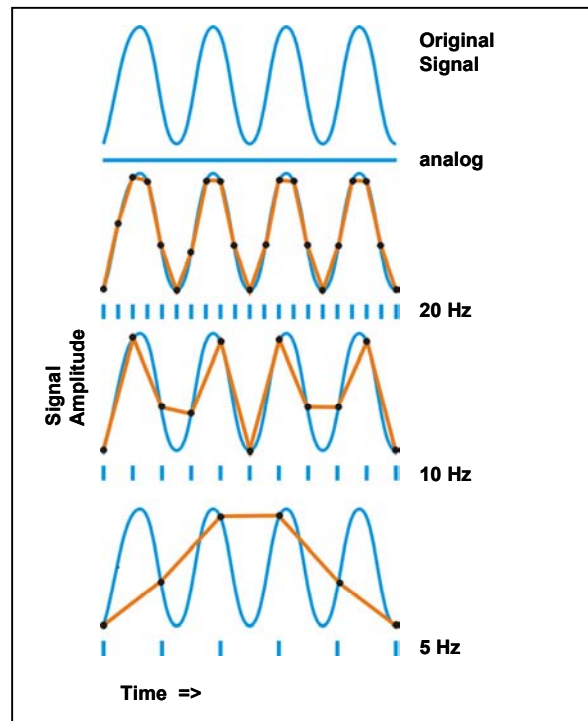

Fig.18: The effect of A/D sampling frequency on a digitized signal. Too low frequencies (lower traces) result in significant loss of signal information

Skin Preparation

General considerations

The quality of an EMG measurement strongly depends on a proper skin preparation and electrode positioning. The main strategy of skin preparation is stable electrode contact and low skin impedance. Most modern EMG-amplifiers are designed for skin impedance levels between 5 and 50 kOhm (between pairs of electrodes). Usually it is necessary to perform some skin preparation before the electrodes can be applied. There are no general rules for it and several possibilities to reach a good skin condition for EMG-measurements exist. Especially for beginners it will be of great value to check the quality of the chosen method by measuring the actual impedance resistance between electrodes with a regular multi-meter or specialized impedance meters (see chapter Signal Check Procedures).

Another important consideration is the targeted test condition and exercise. If a somewhat static or slow motion movement is planned (e.g. a clinical muscle function test) and the basic analysis idea is qualitative (amplitude changes in terms of more/less), a simple alcohol cleaning may be sufficient. If very dynamic conditions with risk of movement artifacts (e.g. fast walking, running or other highly accelerated movements is planned), a very thorough preparation is imperative.

Skin preparation procedures

The following procedures may be considered as steps to prepare the electrode application:

1) Removing the hair:

This is needed to improve the adhesion of the electrodes, especially under humid conditions or for sweaty skin types and/or dynamic movement conditions.

2) Cleaning of the skin:

Method A:

Special abrasive and conductive cleaning pastes are available which remove dead skin cells (they produce high impedance) and clean the skin from dirt and sweat.

Method B:

Alternatively a very fine sand paper can be used: A soft and controlled pressure in 3 or 4 sweeps usually is enough to get a good result. Attention: Avoid any harm to the skin from rubbing too hard! The use of sandpaper should be combined with an alcohol pad.

Method C:

The pure use of alcohol may be another alternative if used with a textile towel (that allows soft rubbing). This latter method may be sufficient for static muscle function tests in easy conditions.

Whichever skin preparation method and electrode application technique is used, when done properly, the skin typically receives a light red color. This indicates good skin impedance condition.

Surface Electrode Selection

Skin surface electrodes

Due to their non-invasive character in most cases surface electrodes are used in kinesiological studies. Besides the benefit of easy handling, their main limitation is that only surface muscles can be detected. For deeper muscles (covered by surface muscles or bones) fine-wire or needle electrodes are inevitable. At best case a free selection of any electrode type is supported by an EMG – (pre-) amplifier. The selection of an electrode type strongly depends on the given investigation and condition, one electrode type cannot cover all possible requirements!

For surface electrodes, silver/silver chloride pre-gelled electrodes are the most often used electrodes and recommended for the general use (SENIAM). Besides easy and quick handling, hygienic aspects are not a problem when using this disposable electrode type. The electrode diameter (conductive area) should be sized to 1cm or smaller.

Commercial disposable electrodes are manufactured as wet gel electrodes or adhesive gel electrodes. Generally wet-gel electrodes have better conduction and impedance conditions (=lower impedance) than adhesive gel electrodes. The latter one has the advantage that they can be repositioned in case of errors.

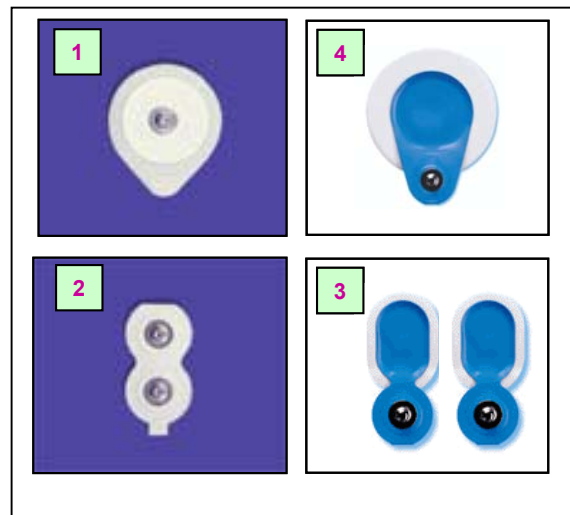

Fig.19: Selection of special EMG electrodes (1,2 NORAXON INC. USA) and regular ECG electrodes (3,4 AMBU-Blue Sensor)

Vaginal and anal probes

For pelvic floor muscle evaluation special anal and vaginal probes are established (Fig. 20) and e.g. often used for incontinence testing and biofeedback training. The use of this electrodes may require special signal processing, especially a highpass filtering (e.g. 20 to 60 Hz) to eliminate heavy movement and contact artifacts. The latter ones are typical and unavoidable within pelvic floor EMGs because there is no fixed connection between the electrode detection area and the muscle surface.



Fig.20: Original Perry probes for vaginal (left) and anal (right) applications

Fine Wire electrodes

The use of fine wire electrodes

Due to muscle movements within kinesiological studies, thin and flexible fine wire electrodes are the preferred choice for invasive electrode application within deeper muscle layers.

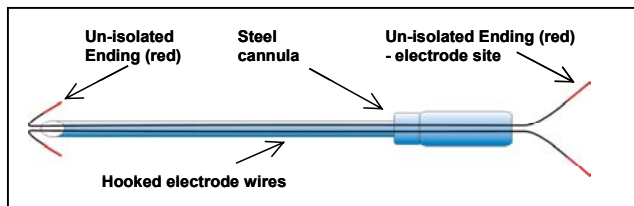

Fig.21: Schematics of a fine wire electrode: two fine wires with un-isolated endings are located with a steel cannula. System MEDELEC.

The sterilized paired or single hook wires are inserted by hollow needles and their proper localization can be tested by electrical stimulators or ultrasound imaging:

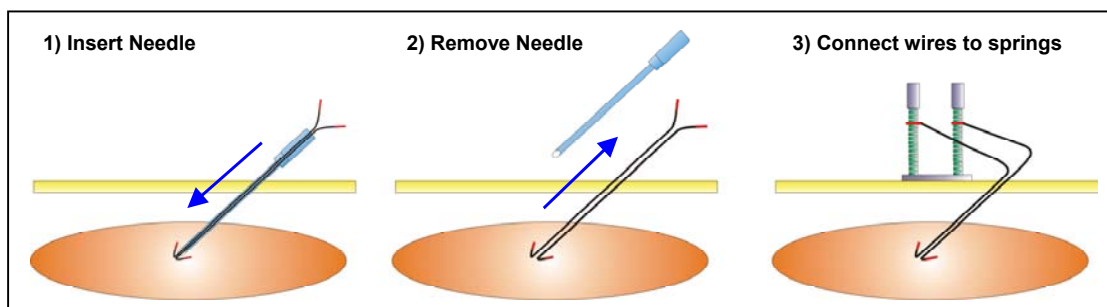
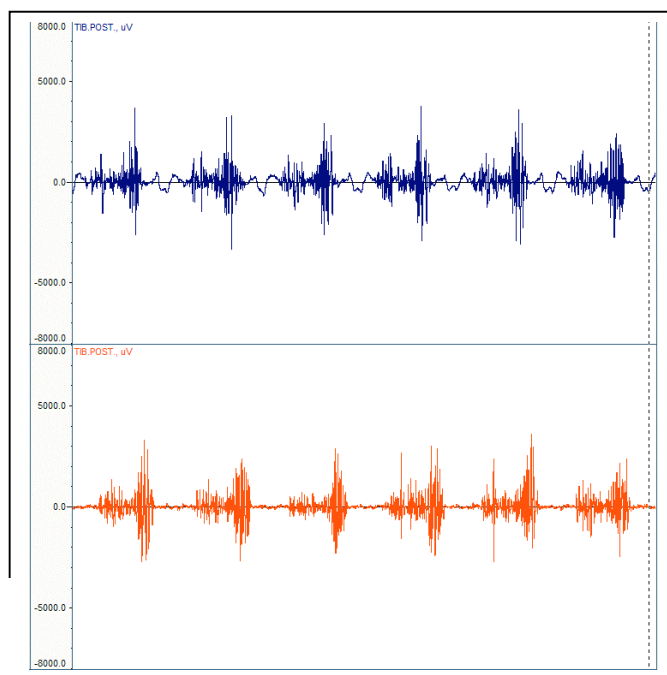

Fig.22: Procedure to insert the fine wires into the muscle tissue. After removing the needle, the distal endings of the wires are connected to steel spring adapters, which again are connected to the regular EMG pre-amplifier lead

The signals are measured and processed like regular surface EMG signals. It may be helpful or necessary to apply a high pass filter at 20 Hz (instead of 10Hz) to eliminate baseline shifts which typically appear from wire movement artifacts within the muscle tissue.



Fig.22: Raw fine wire EMG recording of the *M. tibialis posterior* (upper blue trace) in treadmill- walking. Baseline shifts indicate motion artifacts. The baseline can be stabilized by applying a 20 Hz highpass filter (lower red curve)



Guidelines Electrode Application

General guidelines

- Wet gel electrodes have the best skin impedance values
- Use small electrodes to increase the selectivity of your measures (avoid cross-talk)
- The smaller the electrode (active detection area) the higher the impedance values
- Select the closest possible inter-electrode distance to increase selectivity
- The general recommendation for the inter-electrode distance is 2 cm (center point to center point)
- Apply electrodes in parallel to the muscle fiber direction
- Use the most dominant middle portion of the muscle belly for best selectivity
- Avoid the region of motor points if possible (see next page)
- Take care that the electrode site remains on the active muscle mass during muscle shortening
- Use a map system with measured distances between the electrode site and dominant anatomical landmarks (Fig. 23)
- Use electrodes with de-centralized snap/cable connection if you expect increased pressure on electrodes (e.g. sitting on electrodes)

Anatomical landmarks

Most recommendations for electrode application (e.g. SENIAM) work with an anatomical landmark system, based on dominant bone areas and prominences or other structures that can easily be palpated. Use these points to clearly locate the position of a selected electrode site:

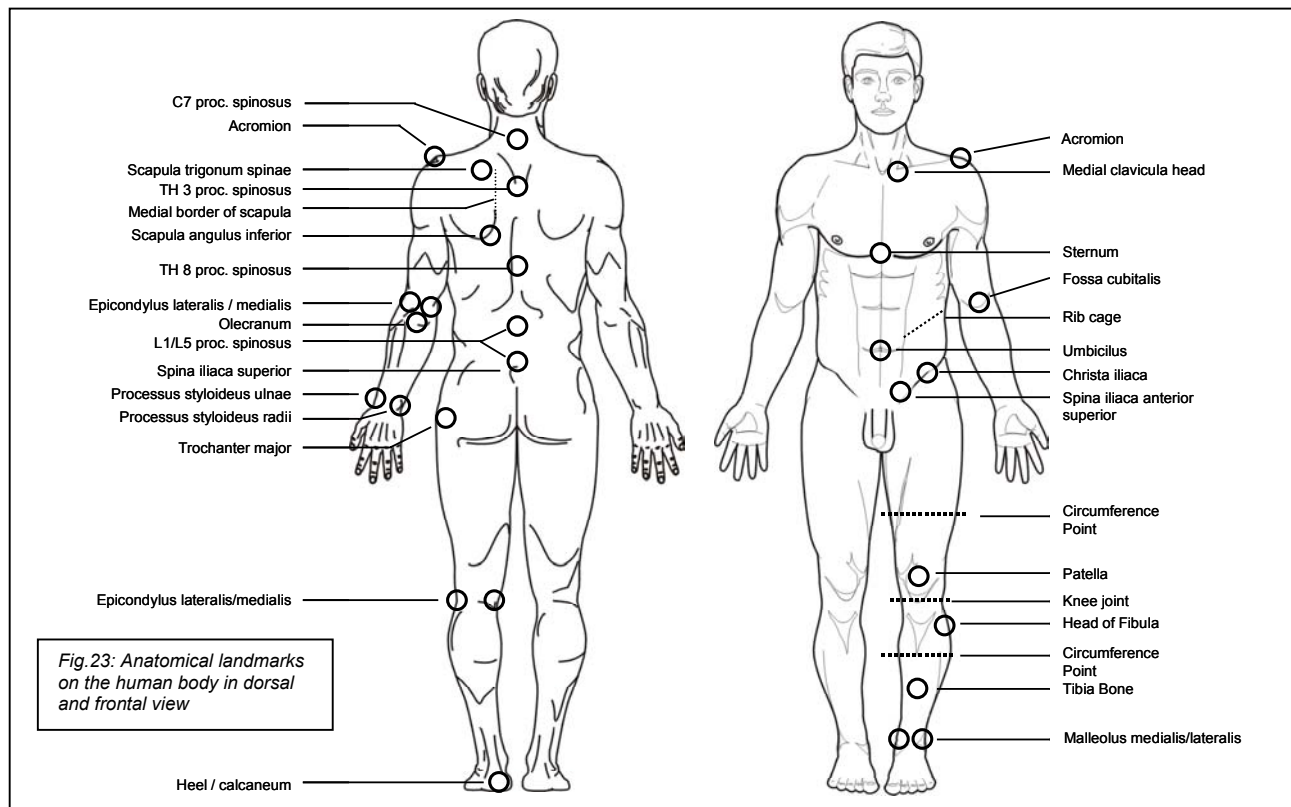

Specific Aspects of Electrode Application

Motor point regions

Due to increased signal instability some researchers recommend not to place electrodes over motor point regions (area with high density of motor endplates) of the muscle. When using electrode sizes as recommended above, in many cases it cannot be avoided that one electrode comes near a motor point region. Motor points can be detected by low frequency stimulus power generators producing right angled impulses.

Relative movement of the muscle belly

For dynamic studies it is very important to locate the electrode pair in a central position over the muscle belly keeping in mind the possible muscle migration below the electrode site during joint movement. The M. vastus medialis and M. biceps brachii are two muscles which require special care to avoid dislocation of the electrodes away from the active muscle mass as shown below:

Another aspect is the shortening and lengthening of the skin itself. This problem is most dominant at the M. rectus abdominis, the M. erector spinae and the M. trapezius pars descendens. If single electrodes are used, enough inter-electrode distance (typically 1-2 cm) has to be selected to avoid the situation that the electrodes push themselves off. Double electrodes may quickly separate from the skin in case of dynamic lumbar erector spinae measures because they cannot follow the natural skin stretching.

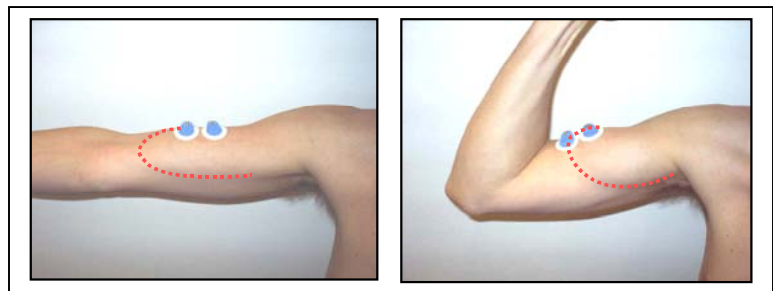

Fig.24: Migration of the muscle belly below the electrode pair attached at the biceps brachii. Note the in the extended position (right picture) the distal electrode has left the active muscle area. It is needed to attach electrodes at center position in the most flexed position.

Cable fixation

Finally, an appropriate cable and pre-amplifier fixation on the skin is needed. This point may be less important for static or slow motion tests, but in dynamic studies it helps to avoid cable movement artifacts and minimizes the risk of separating the electrodes from skin. Use regular tape, elastic straps or net bandages to fixate each electrode lead and avoid too tight tension. It is recommended not to directly tape over the electrodes to keep a constant application pressure for all electrodes.



Fig.25: Cable fixation with elastic straps and tape

Muscle Map Frontal

Most of the important limb and trunk muscles can be measured by surface electrodes (right side muscles in Fig. 25/26). Deeper, smaller or overlaid muscles need a fine wire application to be safely or selectively detected. The muscle maps show a selection of muscles that typically have been investigated in kinesiological studies. The two yellow dots of the surface muscles indicate the orientation of the electrode pair in ratio to the muscle fiber direction (proposals compiled from 1, 4, 10 and SENIAM).

Frontal View

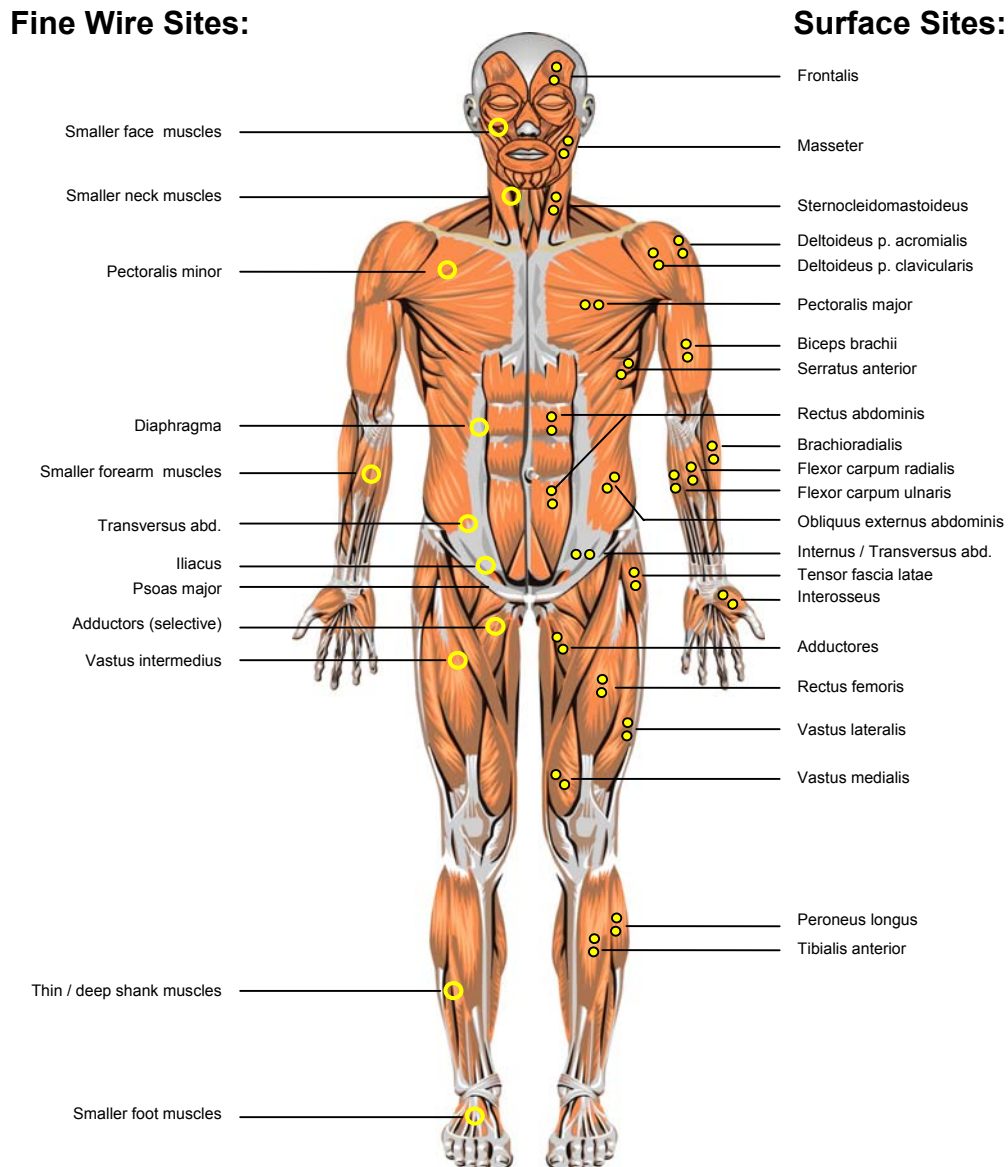

Fig. 25: Anatomical positions of selected electrode sites – frontal view. The left sites indicate deep muscles and positions for fine wire electrodes the right side for surface muscles and electrodes

Muscle Map Dorsal

Dorsal View

Fine Wire Sites:

Surface Sites:

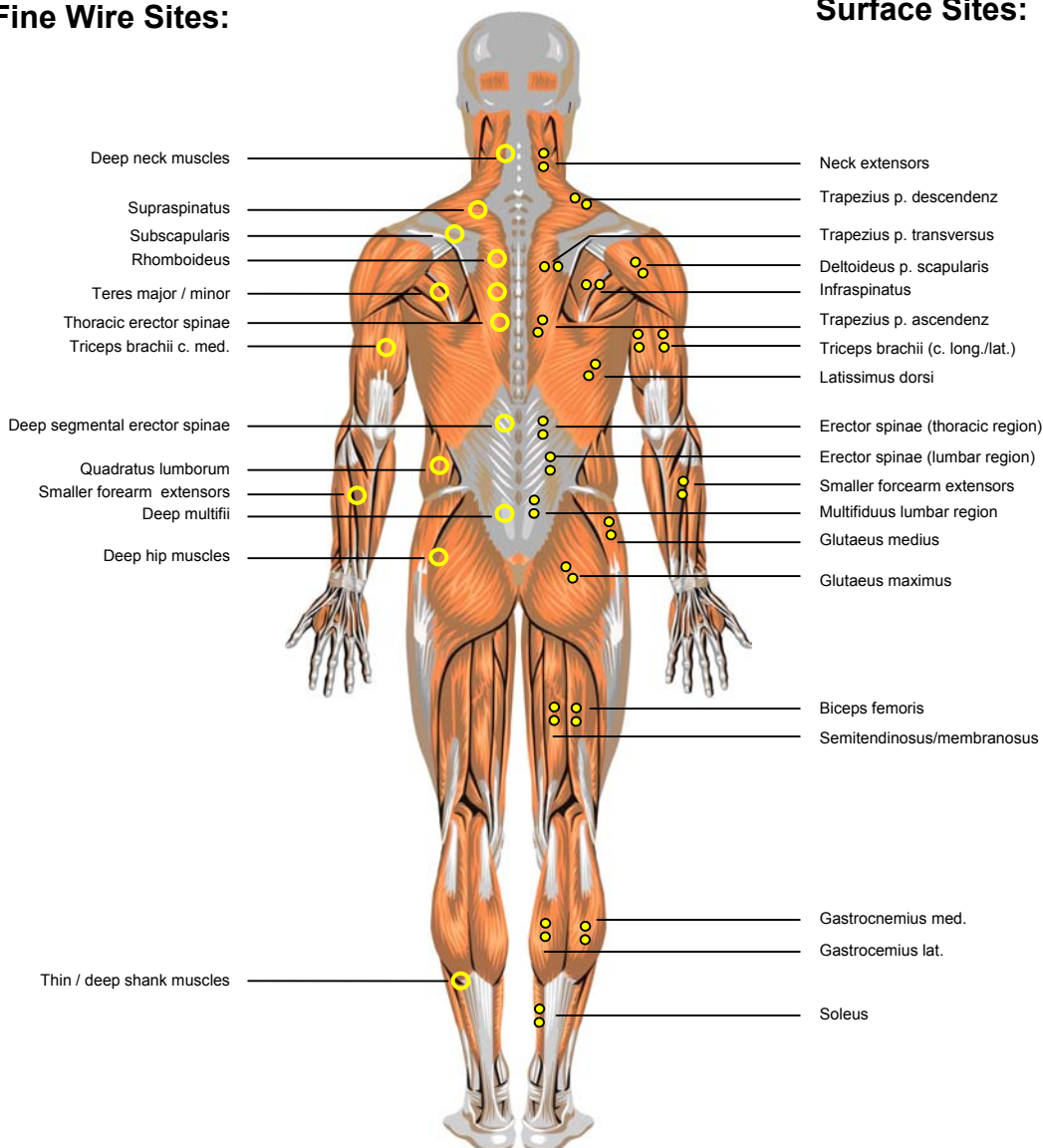

Fig. 26: Anatomical positions of selected electrode sites – dorsal view. The left sites indicate deep muscles and positions for fine wire electrodes the right side for surface muscles and electrodes

Reference electrodes

At least one neutral reference electrode per subject has to be positioned. Typically an electrically unaffected but nearby area is selected, such as joints, bony area, frontal head, processus spinosus, crista iliaca, tibia bone etc. The latest amplifier technology (NORAXON active systems) needs no special area but only a location nearby the first electrode site. Remember to prepare the skin for the reference electrode too and use electrode diameters of at least 1 cm.

Signal Check Procedures

It is an important procedure within all EMG investigations to check the validity and quality of the EMG signals regardless of which skin preparation method and electrode application technique is used. Several steps should be considered here:

1) Proof of the EMG-signal validity

This check point addresses the basic questions: did I measure the right muscle and can I see valid signals at all? Very often, even though it sounds silly, there is a risk to accidentally exchange the cable endings, e.g. the wire designated for one muscle is mixed with another. Checking all connections again can confirm the EMG signal by a specific muscle function test for that particular muscle. Later, within the quality check of the EMG baseline (next chapter) you may also check the sensitivity of an electrode site against cable movement, limb movements and local pressure (e.g. when sitting on electrodes). Detection sites over very fat subcutaneous fat tissue (e.g. more than 4 cm) may mean that no EMG signal is visible at all or the EMG to baseline ratio is too poor. Explicit/isolated static test contractions based on muscle function tests give you a clear understanding if the EMG recording will reveal valid data and/or if the subject is able to activate the muscle.

2) Impedance Test

If the skin preparation was done properly, the skin typically gets a light red color. This indicates good skin impedance condition. To verify it, the Ohm – resistance between the electrode pair can be measured. This step is especially recommended for beginners and for sophisticated research studies (some journals require the control of the typical skin impedance condition). Usually the application area needs about 5 minutes to reach a stable electrical condition: within the first minute one can observe a decrease of electrical resistance of over 50%, mainly due to chemical changes within the skin layers. Skin impedance ranges can be classified



in: Fig. 27: EMG electrode impedance tester – model NORAXON INC USA

Impedance range (KOhm)	Recommendation
1 - 5	-very good condition
5 - 10	- good and recommended if feasible
10 - 30	- acceptable for easy conditions
30 - 50	- less good, attention is needed (see next chapter)
> 50	- should be avoided or requires a second cleaning run

Fig. 28: Recommendations for electrode/skin impedance ranges

Signal Check Procedures

3) Inspection of the raw EMG-baseline quality

The (visual) inspection of the raw EMG baseline is the most important step and cannot be replaced by any other method (like automatic impedance check). The amplifier has to pick up a signal no bigger than a few millions of a volt (microvolt) and this sensitive signal can easily be influenced by external sources (artifacts) if not treated correctly. After connecting the electrodes to the amplifier, start the PC-signal monitor and zoom in the raw EMG trace of each channel to allow a detailed inspection. Ask your subject to completely relax. At best case let your subject lay down on a therapy bench or similar position that allows true relaxation. The EMG baseline inspection focuses on these three major factors:

1) Baseline noise

A complete noise-free recording is impossible: small amplitude spikes or random nature may be visible but they should not exceed 10 – 15 microvolts. The average noise level (=calculate the EMG mean amplitude of the raw rectified EMG for 5 seconds) should be located at 1 (=excellent) to 3.5 microvolts. A frequency distribution test (next page) is a second objective possibility to check the baseline quality.

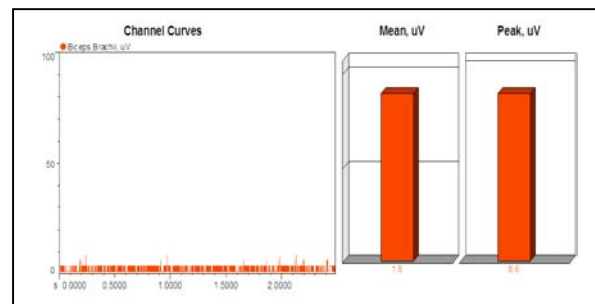
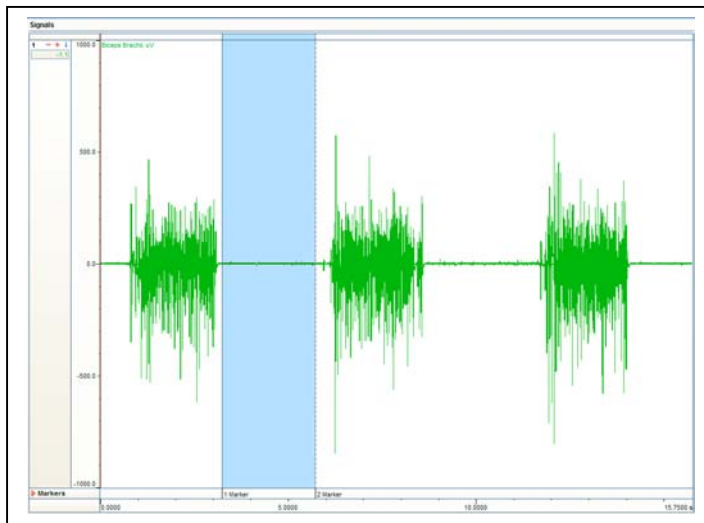

Fig. 29: Visual (left) and numerical (right) evaluation of the EMG baseline quality. The left raw EMG trace shows an example for a nearly perfect EMG recording with stable flat EMG baseline between active contractions. A quick analysis of a baseline section (blue area) indicates a mean noise level of 1.8 microvolts. System NORAXON INC USA.

2) Baseline offset

Most amplifiers work with an auto offset correction. However, it is possible that the EMG baseline is shifted away from the true zero line (test: mean value of the raw EMG \neq zero). If not identified and corrected, all amplitude based calculations are invalid for that record.

1) Baseline shifts

The baseline before/after contractions has to constantly remain at the zero line (see EMG Artifacts, baseline shifts)

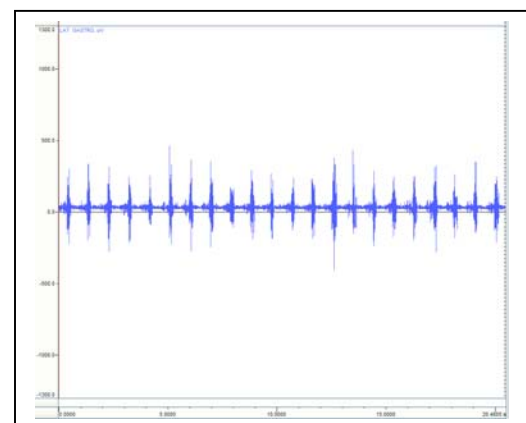

Fig. 30: Example for an offset shifted baseline. Special post recording edit functions should be applied to correct the shift

Signal Check Procedures

4) Frequency distribution analysis

Today's computer capacities allow for an easy and quick check of the EMG frequency distribution. Given the recommended amplifier bandpass settings from 10 Hz high-pass up to at least 500 Hz low pass (SENIAM, ISEK); most of the surface EMG frequency power is located between 10 and 250 Hz. This power distribution can be calculated by the "Fast Fourier Transformation" (FFT) and graphically presented as a **Total Power Spectrum** of the EMG signal (Fig. 31), which shows the frequency power distribution (Y-axis) in ratio to the frequency band (X-axis).

The precise shape of the total power spectrum can vary widely, depending on the FFT-settings and the measurement conditions (especially muscle type, muscle length and tissue/skin filter effects). To perform a signal check test, ask your subject to contract the investigated muscle against static resistance (about 40 – 60 % of the perceived maximum contraction level) and measure a 3 –5 second EMG portion. When stored, select an analysis interval, e.g. 1 second and start a power spectrum analysis. Investigate the characteristics of the spectrum:

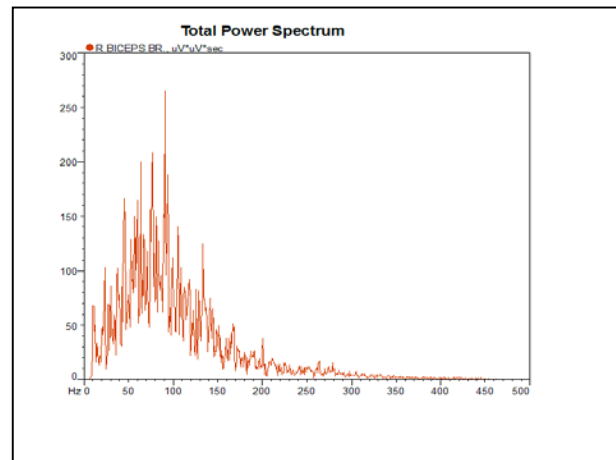

Fig. 31: The total power spectrum of a surface EMG recording: most of the signal power is located between 10 and 250 Hz.

- step increase from the high pass (10Hz)
- the peak frequency is typically located between 50 and 80 Hz
- from here the spectrum curves decreases and reaches zero between 200 and 250 Hz
- observe if untypical power peaks are visible, especially outside the band-range
- check if a dominant power peak is visible at 50 (EU) or 60 (USA) Hz.

The total power spectrum can easily identify power hum contaminating the EMG baseline (Fig. 32) and gives a clear separation to an increased EMG activity which may appear if a subject is not able to relax a muscle.

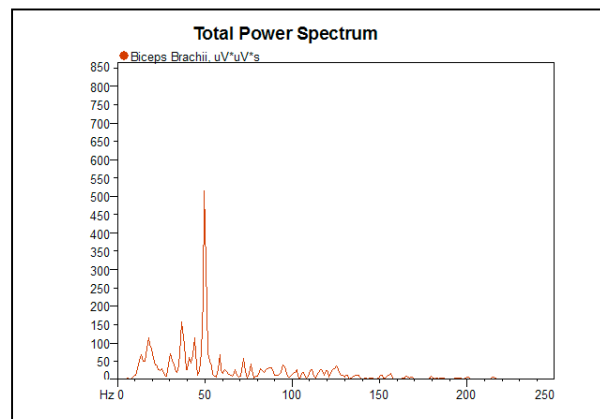

Fig. 32: The total power spectrum of a hum contaminated EMG recording: The high power peak at 50 Hz identifies the noise contamination of the recording, typically due to increased electrical ground noise of the power net within the selected room (also see fig. 33)

EMG Artifacts

Due to its sensitive nature (signal range starts from a few microvolts) the EMG signal can be influenced by external noise sources or other artifact sources. Most of them can easily be avoided if the previously mentioned guidelines of proper skin preparation and electrode position are checked. To give a better picture of possible disturbances, the following graphs show some typical noise or artifact contaminated signals.

Interfering power hum

An EMG amplifier can “catch” ground noise from the power net which results in increased baseline noise (50/60 Hz noise – Fig. 33). If the electrode was applied properly, in most cases another device (with poor electrical grounding) causes this problem. To solve it correctly, ground all devices, especially when equipped with electro-motors (treadmills, training machines, isokinetics machines etc...). Also try to change the power plug and always try to avoid multiple plug connectors and cable drums for the EMG amplifier.

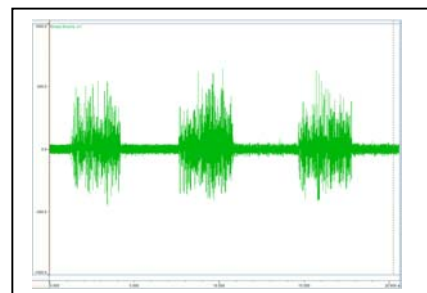

Fig. 33: EMG raw recording contaminated by power hum noise

Baseline offset

This constant EMG - baseline shift may occur if any change within the application site was done after the auto-calibration or if the subject did not relax at measurement start (Fig. 34). Use an “Offset correction” function to correct this shift before you record your data.

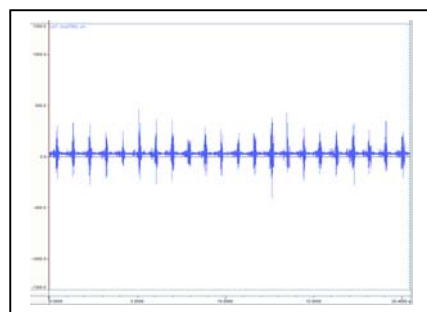

Fig. 34: EMG raw recording with offset shift to plus

Baseline shifts

Any regular EMG burst returns to zero within a few milli-seconds, the EMG rest-line stays at constant zero. Any visible shift > 5 ms indicates an artifact (Fig. 35). This typically occurs if the cables shake too much or if the volume distance between the muscle belly and electrode site is changed by e.g. external lever arm forces (bad cable fixation) or local pressure. In jump testing, you may see similar base shifts due to heavy dislocation of the muscle belly (muscle wobbling due to impact forces) Proper electrode/cable fixation and very good skin preparation can solve these problems.

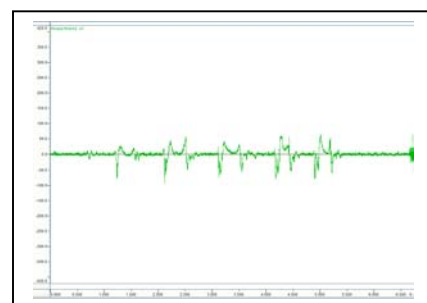

Fig. 35: EMG raw recording with cable movement artifacts

ECG artifacts

Whenever you measure near the heart (shoulder and trunk muscles on the left side), ECG bursts may contaminate the EMG recording (Fig. 36). This is a biological artifact that often cannot be avoided. It can be reduced by very good skin preparation and modified position of the ground electrode. State of the art signal processing routines can “clean” these bursts without destroying the regular EMG characteristics (see chapter Signal Processing ECG Reduction).

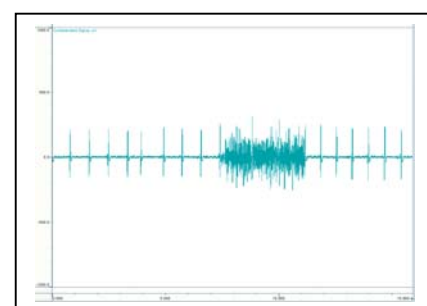

Fig. 36: EMG raw recording with ECG spikes

Prepare EMG - Action list

Action / Step	Comments
1. Ask your subject to wear appropriate clothes	You need access to muscles which may be covered by pants, etc. Too stiff clothes on the electrodes may produce artifacts
2. Decide for a “navigation” technique to identify the electrode location and landmark prominent regions	Use a pen to mark landmarks and orientation lines. Use a flexible scale band to measure distances. Follow the e.g. SENIAM guidelines.
3. Clean the skin with abrasive /conductive fluid	Easiest and fastest method! Alternatively: very good alcohol cleaning
4. Attach electrodes parallel to muscle fibers at typically 2cm electrode distance, use the smallest electrode type available	If possible avoid motor endplates (static tests) and select middle belly portions to increase selectivity and decrease the risk of muscle belly dislocation
5. Wait at least 3 minutes and use the time to stretch, warm up or prepare your subject	The electrode to skin contacts need some time to reach a stable electrical (impedance) condition. Beginners may want to check the electrode impedance
6. Connect and fixate cables	For dynamic movements fixate all leads, leaving enough freedom to avoid lever forces on the electrodes
7. Ask your subject to lay down on a bench and relax	Similar positions like laying on the ground or sitting may work well too
8. Start the signal monitor and check each EMG trace: Baseline check!	Check noise level, zero offset and possible shifts within joint movement
9. Check EMG activity bursts: do I see EMG?	By using manual muscle tests, the general appearance of EMG bursts should be checked

Signal Processing - Rectification

General comments

The raw EMG recording already contains very important information and may serve as a first objective information and documentation of the muscle innervation. The “off-on” and “more-less” characteristics and other qualitative assessments can directly be derived and give an important first understanding of the neuromuscular control within tests and exercises. If a quantitative amplitude analysis is targeted in most cases some EMG specific signal processing steps are applied to increase the reliability and validity of findings. By scientific recommendation (ISEK, SENIAM) the EMG recording should not use any hardware filters (e.g. notch filters), except the amplifier bandpass (10 – 500 Hz) filters that are needed to avoid anti-aliasing effects within sampling. At best case, the post hoc processing can be removed at any time to restore the raw data set. Some of the well established processing methods are introduced in the following chapters.

Full wave rectification

In a first step all negative amplitudes are converted to positive amplitudes, the negative spikes are “moved up” to plus or reflected by the baseline (Fig. 37). Besides easier reading the main effect is that standard amplitude parameters like mean, peak/max value and area can be applied to the curve (raw EMG has a mean value of zero).

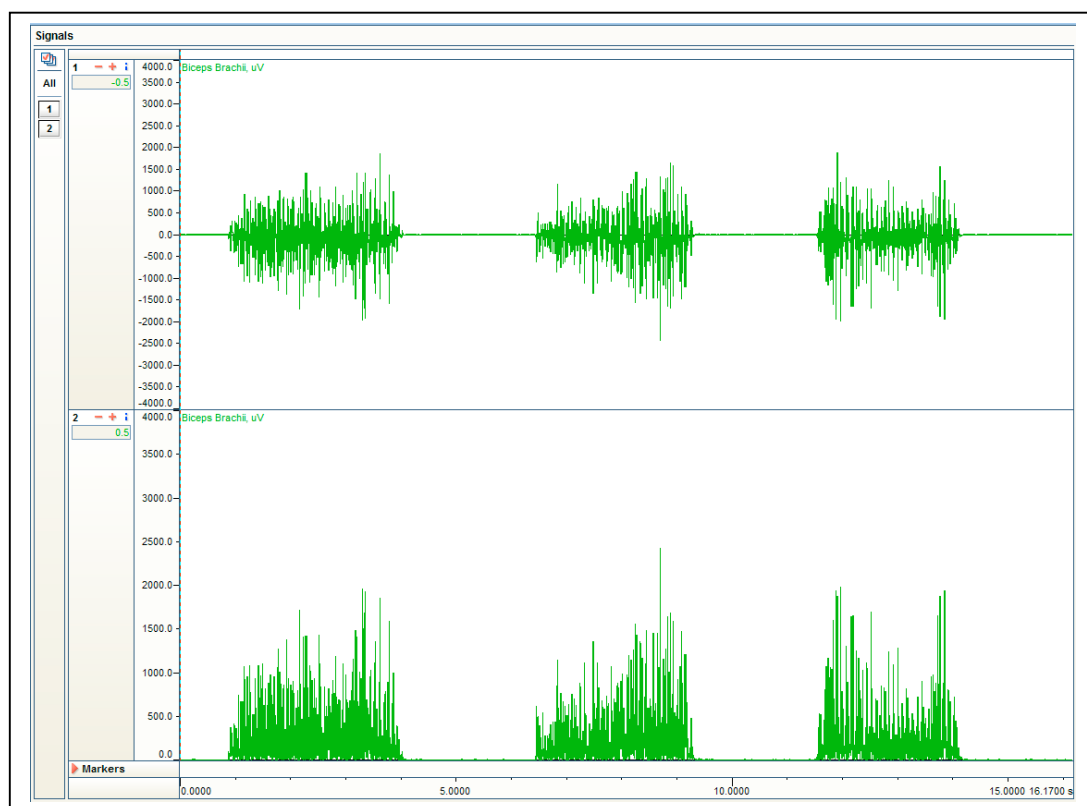

Fig. 37: EMG raw recording with ECG spikes

Signal Processing - Smoothing

General comments

As stated above the interference pattern of EMG is of random nature - due to the fact that the actual set of recruited motor units constantly changes within the diameter of available motor units and the way they motor unit action potentials superpose is arbitrary. This results in the fact that a raw EMG burst cannot be reproduced a second time by its precise shape. To address this problem, the non-reproducible part of the signal is minimized by applying digital smoothing algorithms that outline the mean trend of signal development. The steep amplitude spikes are cut away; the signal receives a “linear envelope”. Two algorithms are established:

Moving average (Movag) Based on a user defined time window, a certain amount of data are averaged using the gliding window technique. If used for rectified signals it is also called the Average Rectified Value (AVR) and serves as an “estimator of the amplitude behavior” (SENIAM). It relates to information about the area under the selected signal epoch (Fig. 38).

Root Mean Square (RMS) Based on the square root calculation, the RMS reflects the mean power of the signal (also called RMS EMG) and is the preferred recommendation for smoothing (2, 3).

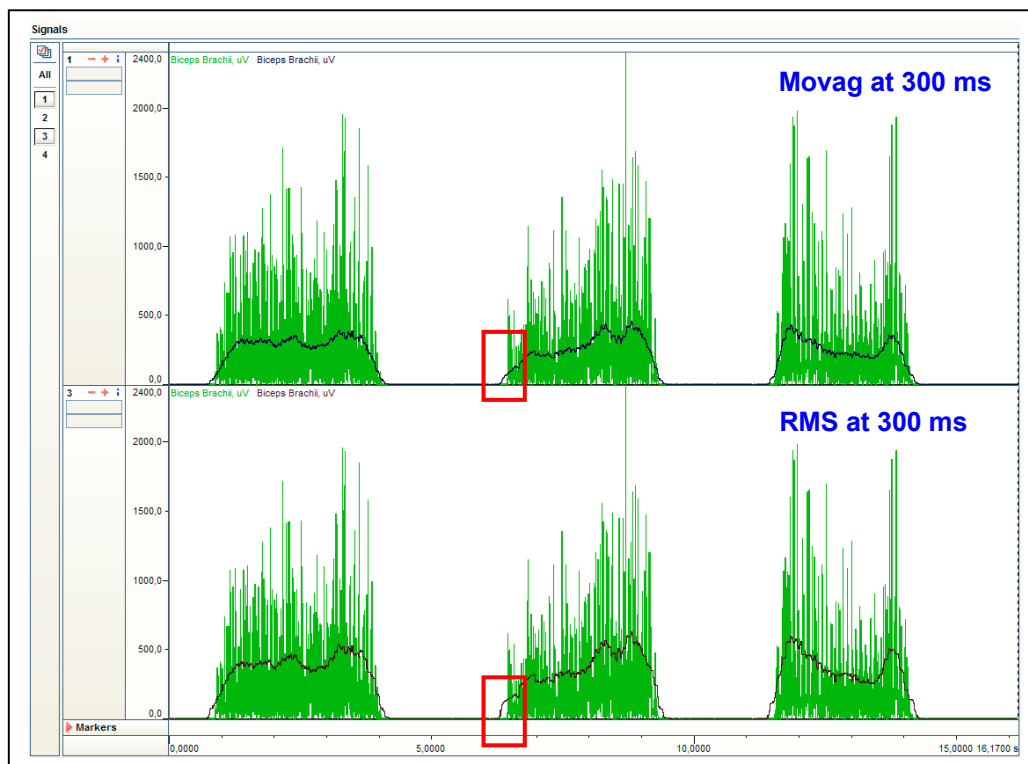

Fig. 38: Comparison of two smoothing algorithms using the same window width: Being very similar in shape, the RMS algorithm (lower trace) shows higher EMG amplitude data than the MovAg (upper trace)

Both algorithms are defined for a certain epoch (time window) and typically in kinesiological studies time duration of 20 ms (fast movements like jump, reflex studies) to 500 ms (slow or static activities) are selected. A value that works well in most conditions is between 50 and 100 ms. The higher the time window is selected, the higher the risk of a phase shift in contractions with steep signal increase needs to be considered (see red rectangle in Fig. 38).

Signal Processing - Digital Filtering

General comments

With the exception of amplifier bandpass filtering additional filtering is not needed in regular kinesiological EMG studies (performed with modern amplifier technology). Scientific recommendations for research studies (SENIAM, ISEK) deny any narrower band setting and the target is to measure the EMG in the full band length of 10 to 500 Hz. Especially any type of notch filter (to e.g. cancel out 50 or 60 Hz noise) is not accepted because it destroys too much EMG signal power. Biofeedback units working with heavily preprocessed signals should not be used for scientific studies.

Application of filters in EMG

In certain situations, it may be suitable to apply additional digital filters. Alternatively to Movag and RMS smoothing, a low pass filter at 6 Hz (e.g. Butterworth, 2nd order or higher – see Fig. 39) can be used to create a linear envelope EMG (11). One benefit of higher order digital filters is that it can be applied recursively to minimize the phase shift phenomenon mentioned in the previous chapter.

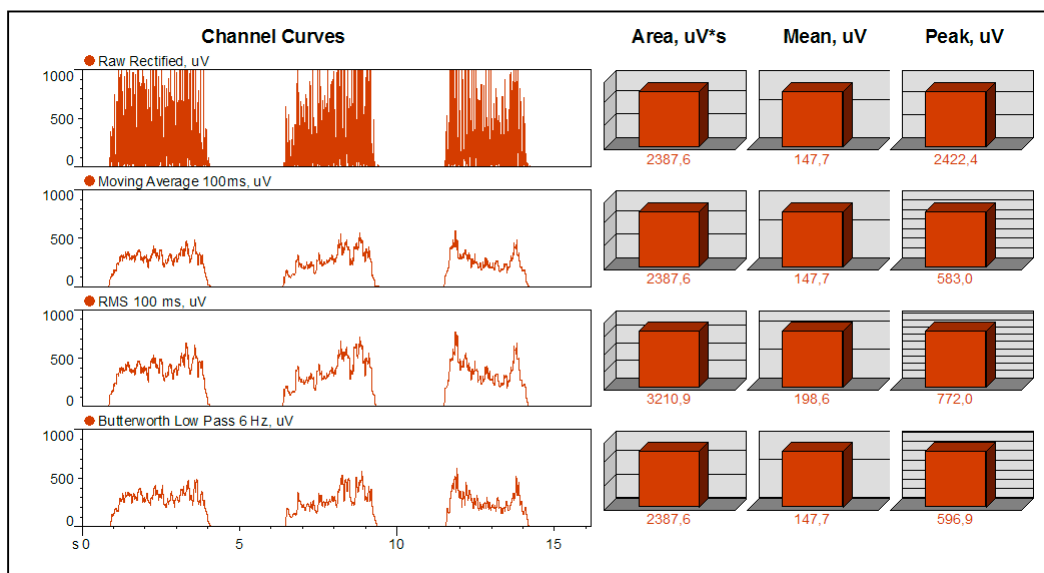

Fig. 39: Comparison of three smoothing algorithms and their effect on amplitude shape and statistics. The 6 Hz Butterworth Low Pass filter (lowest channel) compares to a MovAg with 100ms window width. Both show the same shape and identical amplitude parameters

Fine wire studies may suffer from the wire movement artifacts within dynamic studies (see Fig.22). They often can be minimized by applying a high pass filter at 20 – 25 Hz (See chapter Fine wire electrodes). Such a filter setting does not significantly change the ensemble average curves e.g. typically processed in gait studies (see chapter Average EMG / Ensemble Average). The use of vaginal or anal probes can be improved by setting high pass filters to stabilize baseline shifts due to instable contact between probe and muscle /skin surface. Finite Impulse Response filter (FIR) and Infinite Impulse Response Filter (IIR) with several sub classes (window edge fading) exist and specialists may identify optimal filter settings and coefficients to best fit a signal to a given purpose. Otherwise, the rectified RMS smoothed EMG signal without any additional filtering can be considered as a standard processing in kinesiological EMG.

Signal Processing – Amplitude Normalization

General comments

One big drawback of any EMG analysis is that the amplitude (microvolt scaled) data are strongly influenced by the given detection condition (see chapter Influence of Detection Condition): it can strongly vary between electrode sites, subjects and even day to day measures of the same muscle site. One solution to overcome this “uncertain” character of micro-volt scaled parameters is the normalization to reference value, e.g. the maximum voluntary contraction (MVC) value of a reference contraction. The basic idea is to “calibrate the microvolts value to a unique calibration unit with physiological relevance, the “percent of maximum innervation capacity” in that particular sense. Other methods normalize to the internal mean value or a given trial or to the EMG level of a certain submaximal reference activity. The main effect of all normalization methods is that the influence of the given detection condition is eliminated and data are rescaled from microvolt to percent of selected reference value. It is important to understand that amplitude normalization does not change the shape of EMG curves, only their Y-axis scaling!

The concept of MVC Normalization

The most popular method is called **MVC**-normalization, referring to a **Maximum Voluntary Contraction** done prior to the test trials (Fig. 40).

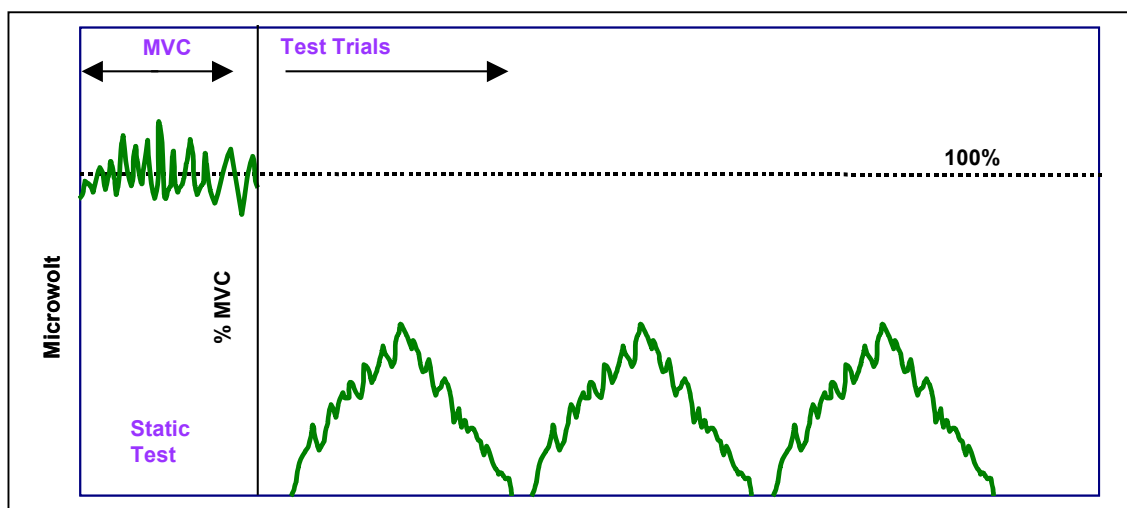

Fig. 40: The concept of MVC normalization. Prior to the test/exercises a static MVC contraction is performed for each muscle. This MVC innervation level serves as reference level (=100%) for all forthcoming trials

Typically, MVC contractions are performed against static resistance. To really produce a maximum innervation, a very good fixation of all involved segments is very important. Normal (untrained) subjects may have problems producing a true MVC contraction level, not being used to such efforts.

Logically, patients cannot (and should) not perform MVCs with injured structures and alternative processing and analysis methods must be considered. Concentrating on treatment issues, a clinical concept would work with the “acceptable maximum effort” (AME) which serves as a guideline for biofeedback oriented treatment regimes. One cannot consider an AME as a MVC replacement which can strongly differ from day to day.

The practice of MVC Normalization

The MVC test has to be performed for each investigated muscle separately. The first step is to identify an exercise/position that allows for an effective maximum innervation (not force output!). For extremity muscles typically isolated single-joint activities - statically fixated at middle positions within the range of motion (ROM) - give best results. For trunk muscles exercises innervating the given “muscle chain” work best. Whenever possible, use robust machines with fixation belts. It is interesting to note that depending on the subject’s individual coordinative capacity different test exercises/positions can produce the highest MVC value, especially for trunk muscles: it may be needed to try out two or three possible good candidates of test exercises and check, where finally the highest EMG level can be found. For complex studies addressing trunk and hip muscles, it is recommended to organize a sequence of these “best candidates” and let them be performed in random order (Fig. 41).

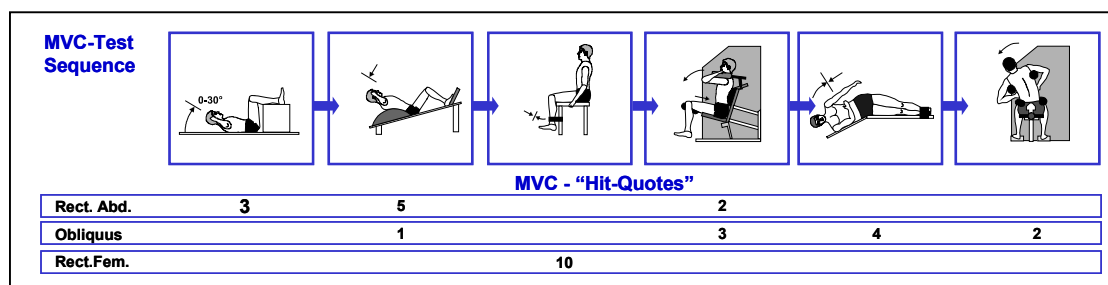

Fig. 41: MVC test sequence for trunk/hip flexor muscles (Rectus abd., Obliquus ext. abd., Rectus femoris). The numbers below each test exercise indicate how many of 10 subjects showed highest innervation at that exercise.

After an initial warming up sequence (stretching, low aerobic exercises, 5 to 10 minutes), ask your subjects to start slowly increasing the force, reach the maximum effort after 3 –5 seconds, hold it for 3 seconds and calm down with 3 seconds. Repeat it at least one time, with a pausing period of 30 to 60 seconds in between. Repeat this sequence for each MVC exercise (studies require random order to avoid systematic fatigue effects).

The most economical way is to store all data in one record and pause the recording while changing the test position (Fig. 42). This would allow mathematical algorithms to find peak portions automatically, regardless of which “candidate” produced it. The MVC value itself is not calculated as a single peak data point which would mean too much variability. A more stable reference value is the mean amplitude of the highest signal portion with e.g. 500 ms duration. It has to be determined by algorithms using a gliding window technique

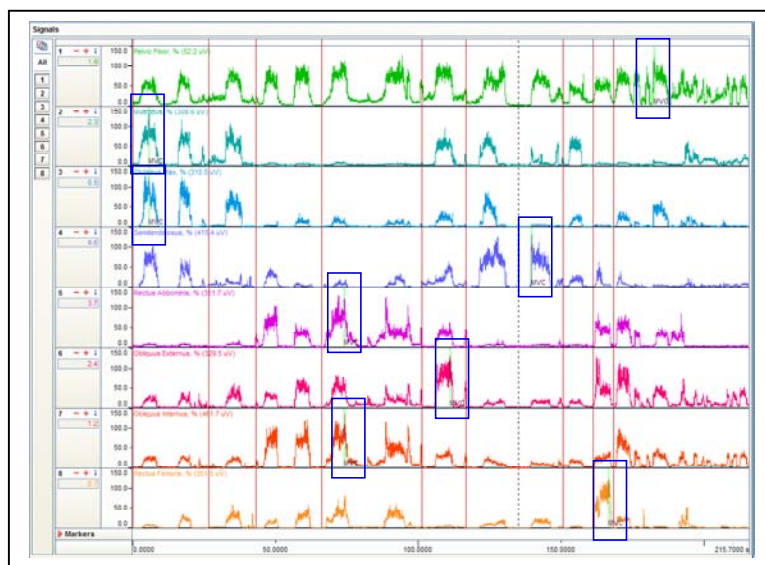

Fig. 42: Example for an 8 channel MVC test sequence. Each MVC – test is repeated at least one time, interrupted by a pausing (red lines). An automatic algorithm detects the highest EMG portions (green bars labelled “MVC”) and stores them for further use. System MYORESEARCH XP, NORAXON INC. USA

Proposal for MVC - test positions

How to arrange a MVC exercise: the most important point is very good fixation and contraction against rigid resistance. Some exercises can be arranged on a regular therapy bench, using belts in combination with manual resistance. Training machines can be very helpful due to their fixation possibilities. The following table is based on practical experience. Systematic research studies on the effectiveness of MVC positions are still missing and some trial and error testing in pre-studies are needed to confirm the best test arrangement.

MVC Positions for forearm / shoulder muscles







Muscle group	Exercise	Comments
Forearm flexors / extensors		Select a seated or kneeling position (in front of a bench) and arrange a stable forearm support. Manual resistance, barbells or cable/belts can be used. Consider using the latissimus d. and pectoralis major MVC test as a control exercise
Biceps Brachii		A valid biceps b. MVC needs a very stable elbow and trunk fixation. This can best be arranged in a seated or kneeling position (in front of a bench). Consider using the latissimus d. MVC-test as a control exercise.
Triceps Brachii		Same instruction as biceps b.! Consider using the pectoralis major MVC-test as a control exercise.
Deltoideus		Select a seated position, if possible with fixated back. Fixate near the arms near the 90° position. The bilateral contractions guarantee a balanced force distribution for the trunk. The abduction works best for the pars acromialis of the deltoid muscle. Consider a flexion/extension position for the pars clavicularis.
Trapezius p. descendens		The MVC test can be performed with one side only. A static resistance can be arranged by manually fixating the arm or arrange a large enough load to press the shoulder down (difficult).
Pectoralis major		Numerous test positions can be used! However, all of them need a very good shoulder/back resistance. The prone lying position would best be performed with a (fixated) long bar. The push up may work as an easy to arrange alternative. Both positions should be performed in 90° elbow position.
Infraspinatus		Being the most important outward rotator of the shoulder cuff, any related outward rotation may work. Good results are achieved with uni- or bilateral manual resistance against the forearm
Trapezius p. trans. / Rhomboideus		The horizontal abduction best addresses the shoulder stabilization muscles. In the prone laying position a barbell or bilateral manual resistance can be used. The seated position requires a good breast fixation and a cable or machine resistance (rowing machines).
Latissimus/Trapezius p. ascendence		The simulation of a pull-up addresses the highest latissimus innervation. Consider/check a frontal and a lateral arm position at 90° elbow flexion. You may find MVCs for the biceps and the lower trapezius also.

Fig. 43a: Proposals for upper body MVC test arrangements. The black thin arrow indicates movement direction, the white thick arrows the resistance direction

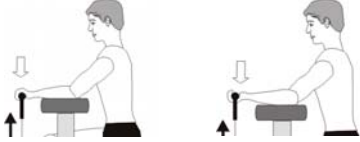
MVC positions for trunk, hip and leg muscles

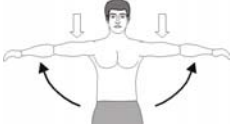
Muscle group	Exercise	Comments
Rectus abdominis Obliquus internus abdominis		A valid MVC test for the abdominals is difficult to arrange. Sit-up styled movements with very good leg fixation (!) work best. Let the spine flex by around 30° and use a belt or manual fixation for that position. The obliques may fire higher when an additional trunk rotation is added to the flexion
Obliquus externus abdominis		This MVC test needs good coordinative skill. A side laying position with leg and hip fixation is a good start position. Let the subject flex up and fixate early in the flexion position. An important check exercise is the MVC test for the rectus abdominis
Erector spinae / Multifidii		The prone laying position on a bench is a very productive MVC test position. Because all back muscles are facilitated within a muscle chain, MVCs for the erector spinae, the gluteus and the hamstrings can be found here. A check exercise is the isolated back extension at a machine
Glutaeus maximus		A control exercise for the gluteus maximus muscle! It should be performed both in extended and flexed knee position with slightly outward rotated legs. The hyperextension position (~20°) is important.
Glutaeus medius		The hip abduction can be performed in fixated side laying position or supine position. Some subjects show higher EMGs in standing position
Mm. adductores		A big and stiff roll cushion is pressed between the flexed legs
Rectus femoris		An easy and beneficial exercise for all quadriceps muscles! A single leg knee extension between 90 and 70° knee flexion position is performed
Mm ischiocruales		Isolated test for the hamstrings. Arrange a very good fixation of the hip (belt/heavy person) and perform a unilateral knee flexion at ~ 20-30° knee flexion. An important check exercise is the prone laying MVC test for the erector spinae
Gastrocnemius		Being one of the strongest human muscles, the triceps surae group needs very rigid (machine) resistance against the fixated hip. Perform an unilateral plantar flexion at 90° ankle position
Soleus		This is an important check exercise for the soleus muscle because the gastrocnemius is at a difficult work position. Perform a unilateral plantar flexion. A very rigid fixation of the knee is needed due to high forces
Tibialis anterior		The tibialis anterior usually can be fixated by manual resistance, work unilateral

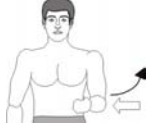
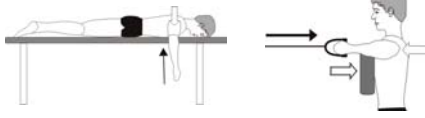
Fig. 43b: Proposals for trunk, hip and leg MVC test arrangements. The black thin arrow indicates movement direction, the white thick arrows the resistance direction

Benefits of MVC-normalization

One important benefit MVC normalized data provides is the estimation of neuromuscular effort “invested” or needed for a given task or exercise. On the microvolt level, it is impossible to estimate the neuromuscular demand because these data are too strongly influenced by the individual signal detection condition. Any “normative” amplitude data published in microvolt values must be used with very special care! MVC normalized data give an understanding at what capacity level the muscles did work, how effective a training exercise “reached” the muscles or how much ergonomical demand a work task is asking from a worker.

The other big benefit of MVC-normalization is the rescaling to percent of a reference value unique and standardized for all subjects within a study. It eliminates any varying influence of local signal detection conditions. This again allows a direct quantitative comparison of EMG findings between subjects. Group statistics and normative data can be developed and statistically be verified.

Drawbacks of MVC-normalization

The MVC concept can only be used in studies done with healthy and trained subjects. And even here, some uncertainties have to be considered: is the subject able to perform a valid trial, did the test exercise correctly “catch” the muscle and is the selected muscle length representative for dynamic movements etc.? Very often supramaximal EMG data can be observed for submaximal dynamic activities. Unfortunately this phenomenon is not systematically addressed by scientific studies and numerous factors may be responsible for it, e.g.:

- Changes in the muscle length due to dynamic movements
- Using a MVC window instead of a peak data point
- Motor unit synchronization and increased electrical superposition within submaximal movements

As previously mentioned, valid MVC data can only be produced with healthy subjects, which were prepared (trained) for the MVC test series. This may make the methodological organization of a study very demanding and time consuming. Consider a 16 channel EMG measurement with one repeated trial; the efforts needed to perform an appropriate MVC test series easily need one hour of preparation. Most reviewers in scientific journals ask for MVC or any other normalization by default. But on a note of caution it may be outlined that MVC tests easily get invalid and produce more data instability/invalidity instead of benefits. Changing the analysis philosophy often makes normalization unnecessary (see analysis chapters below). Especially when working with patient groups, one cannot expect a valid MVC trial at all. In most clinical cases it is better to stay at the microvolt scaling but ensure a very well prepared and standardized skin-/electrode preparation and accept a certain amount of “error” produced by varying detection conditions. In side comparison or repeated day to day tests done with one subject, a rough guideline may be to consider 10 to 15% per se variance due to differing detection condition. However, caution is needed if subjects are compared: at extremes the difference can easily be several hundred percent! Unnormalized EMG patient findings should be analyzed with qualitative scales, direct comparison muscle activity of the same muscle in different test positions, or qualitative description of the curves characteristics within a movement cycle (“muscle behavior”).

Amplitude normalization internal mean or peak value

For ensemble average EMG curves (see next chapter) some researchers recommend the amplitude normalization (based on smoothed rectified EMG) to mean value found within each test/exercise/trial (Fig. 44). The main effect is a reduction of the variability, expressed in smaller coefficients of variance (12 – see Fig. 45). This may have statistical benefits, such as reduced standard deviation range, but since this normalization method (like any other method) does not change the shape and ratios within the averaged EMG curve, the true benefit is academical and of lesser practical relevance.

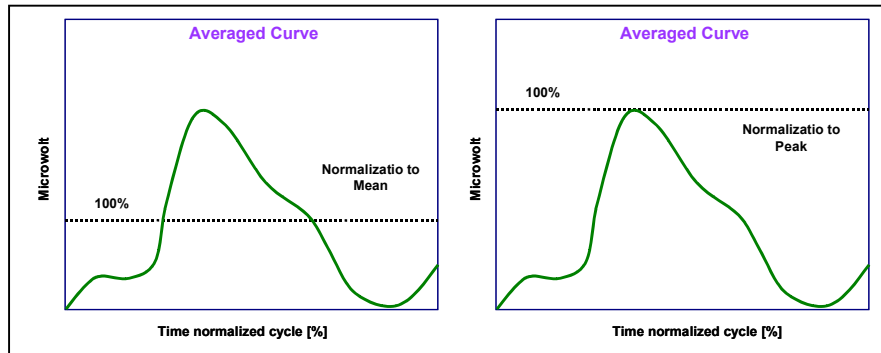

Fig. 44: Amplitude normalization to the test- internal mean (left) or peak value (right) of the averaged curve.

Alternatively, the peak value can be used as a reference point (Fig. 44). Both methods have the big drawback that any (at least qualitative) information about the innervation level is eliminated, e.g. an activation curve near the maximum capacity receives the same dimension as a low level contraction. Any comparison between trials of the same subject and channel will lose the innervation ratio, which is a very important analysis factor for EMG findings. Both normalization methods allow studying the innervation behavior or development of EMG pattern within the investigated repetition cycle (typically gait analysis).

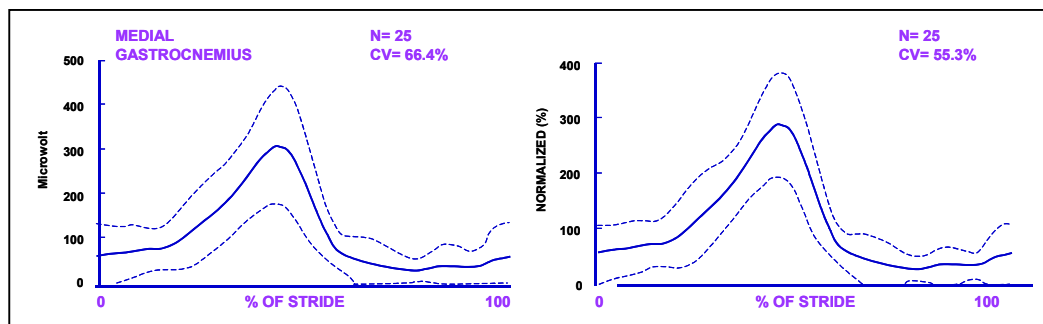

Fig. 45: Comparison of microvolt vs. mean value normalized ensemble averages of the medial gastrocnemius. The shape of the curve is not altered, but the variance (CV-coefficient of variance) is reduced due to mean normalization (left). Redrawn from 11, p. 64

Other normalization methods

Other methods are reported (10), such as using the EMG innervation of a task specific reference activity (e.g. holding the arms in 90° abduction and normalizing the trapezius and deltoid EMG to this position). This approach is very critical and may even add confusion because one will never know about the given individual coordinative (EMG) input within the reference activity. An alternative concept to MVC normalization is the normalization to submaximal EMG levels. This is only practical if the force output can be determined: given the case the subject is able to perform a maximum (force-) effort, the EMG level of e.g. 40% of max force is used for normalization.

Signal Processing – ECG Reduction

How to remove ECG artifacts

As previously demonstrated in the section “EMG-Artifacts”, the ECG spike can contaminate EMG recordings on the upper body. The ECG may be considered as EMG of the heart, but due to electrical synchronization being stronger by a factor of 1000 (millivolt instead microvolts), it can easily migrate through body tissue and reach electrode sites on the upper body. Risk regions are the muscle sites near the heart like the shoulder and upper trunk muscles. It is an unavoidable biological artifact and cannot easily be filtered away. Having a center frequency of 80 Hz, it is located within the peak power region of the EMG frequency spectrum.

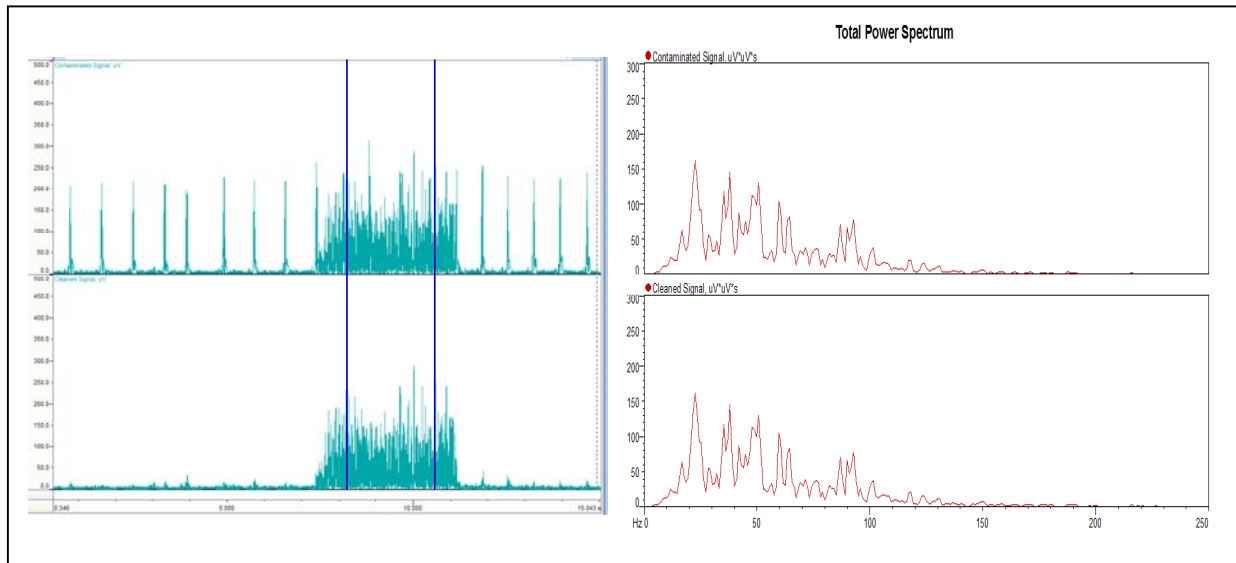

Fig. 46: Example of ECG affected EMG recording (upper trace) and the resulting signal after applying an ECG-reduction algorithm (lower trace). On the right side the FFT power spectrum of the interval between the two marks is shown. Note that both the EMG amplitude and the spectrum are not altered by the ECG reduction. System MyoResearch XP™, NORAXON INC USA

By combining adaptive filter methods with a pattern recognition mode, sophisticated algorithms can “clean” most of the ECG contents without affecting the true EMG amplitude and power spectrum (Fig. 46). Relaxation studies especially suffer from the artifact and without ECG removal significant errors may be introduced to the amplitude calculations.

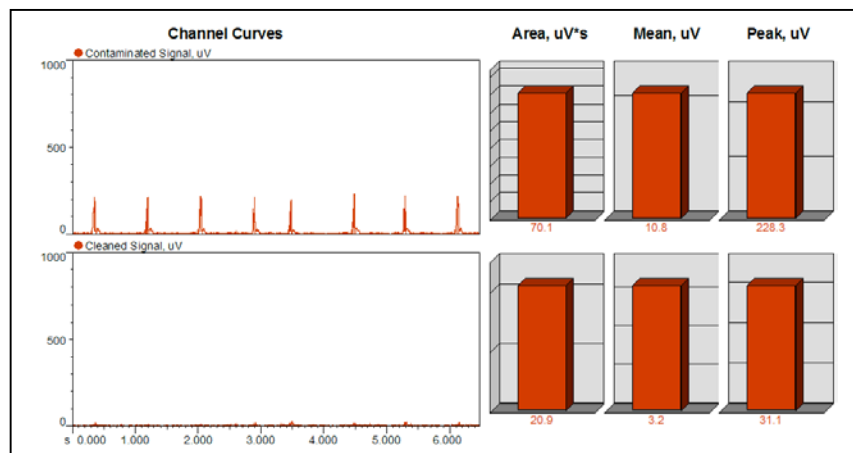

Fig. 47: Calculation errors produced by ECG interference on EMG traces near the rest line (relaxation studies). The amplitude mean value (MEAN) increases from 3,2 (cleaned) to 10,8 microvolt.

Time Normalization for Repetition Cycles

Natural variability within human movements

Even in highly standardized movement patterns or repetition cycles, such as normal gait or isokinetics knee extension/flexion, a significant signal difference is visible in the smoothed rectified EMG between repetitions (Fig. 48). The random nature of the MUAPs superposition (see chapter “Nature of the EMG Signal”) may contribute to part of it, but the more important reason is the coordinative variability which is typical for human locomotion. Not being robots, it is difficult for normal subjects to really reproduce a movement a second time: all biomechanical data/curves reveal variance. Typically, the standard deviation ranges of averaged EMG curves are higher than the e.g. angle or force curves. Beside signal nature, the main reason is the coordinative interplay between muscle agonist, antagonists and synergists, which can be considered as continuous motor control/balancing process between all involved components. To describe the “typical” movement characteristics and neuromuscular input, investigators should consider not to analyze only one repetition but many of them (> 6 up to 30, depending on difficulty and fatigue factor) and average them to the “ensemble average” curve.

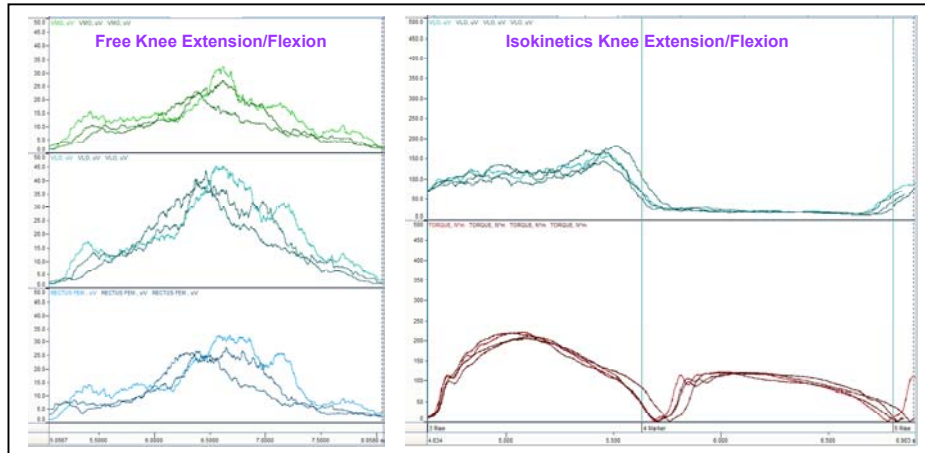

Fig. 48: Variability of single EMG patterns. Left side shows a signal superposition of 3 repetitions for three knee extensors (vastus medialis&lateralis, rectus femoris) for a free squat movement. A considerable EMG variance between repetitions is visible.

On the right side, a signal superposition (3 repetitions) of the vastus medialis EMG (upper trace) and the resulting torque output curve (lower trace) is shown for a concentric/concentric knee extension/flexion at an isokinetics device. The EMG variability is reduced - mainly due to the single joint character of the knee extension in seated position.

The concept of time normalization

It is impossible to precisely repeat the duration of a repetition in human locomotion, even if isokinetics machines (constant movement velocity controlled by machines) are used (Fig. 48). Any averaging of such repetitions requires a time normalized format. The most popular concept, originally developed for gait analysis (11), separates all repetition within a given sequence into an equal amount of periods and calculates the mean value of each period (Fig. 49). The original (milli-) second time scale is converted to “percent of cycle” ranging from 0 to 100%. Usually a segmentation of 100 (= 1 data point at each 1% step) is used.

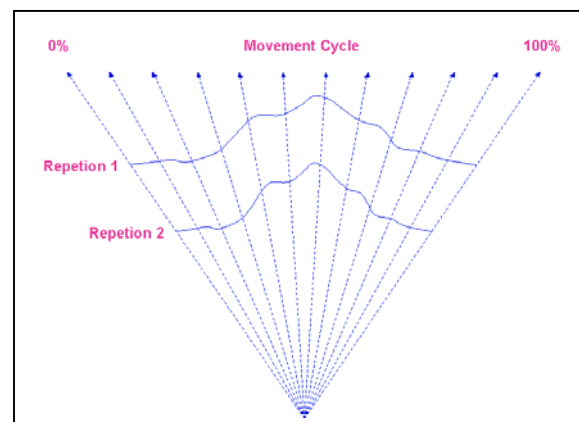

Fig. 49: The concept of time normalization for repetitions/interval of different duration. Each repetition is segmented in a certain amount of equal portions and the mean value of each portion is used for the averaging.

Average EMG / Ensemble Averages

Time normalized averaging

Based on the time normalization described above each repetition is averaged to a mean curve, the average curve or ensemble average curve (Fig. 50). Usually the range of plus/minus 1 standard deviation (SD) is shown to visualize the variability between repetitions (Fig. 51). Big SD-areas indicate less successful repeatability between repetitions or poor test standardization.

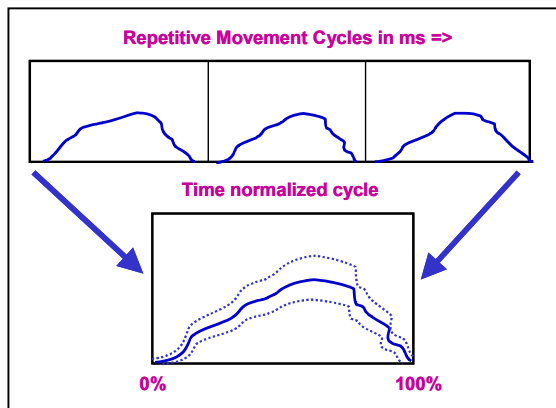

Fig. 50: Generation of an averaged curve within a time normalized frame ranging from 0 to 100%

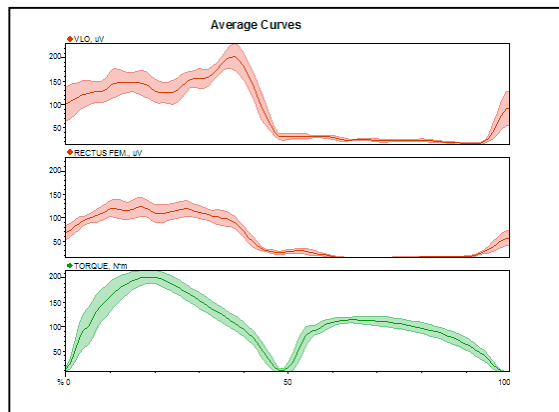

Fig. 51: Example for averaged curves, based on a isokinetic knee extension / flexion sequence at 60°/sec. Red= EMG, green=torque

In clinical testing the coefficient of variance can easily reach values of >50% which is not an abnormal finding for e.g. EMG gait patterns (see Fig. 45).

The strategy of averaging is one of the most important EMG analysis because the ensemble average curves can easily be reproduced if the overall testing standardization is arranged properly. Averaging has an additional “smoothing effect” on the EMG pattern.

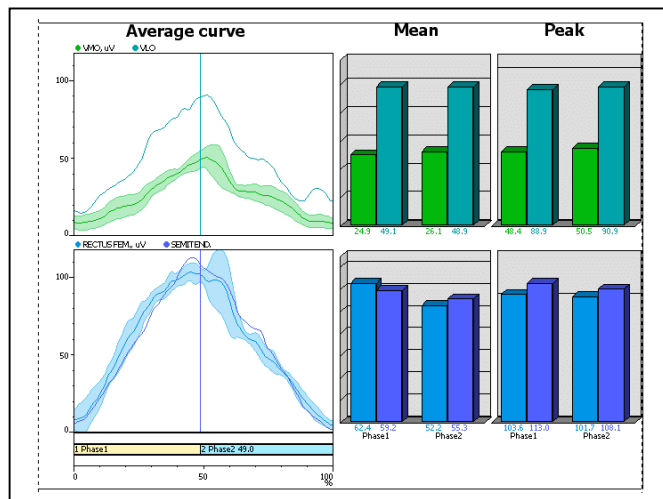

Fig. 52: Comparisons of average EMG curves within the unique time format resulting of time normalization. EMG Pattern difference can easily be detected, qualitatively described and quantitatively be calculated if the same muscle is investigated in two different test conditions. If muscles (=different detection conditions!) are compared, the quantitative comparison should be avoided and the focus is set to the “innervation behaviour”.

Another big advantage is the unique time format which allows group averaging and comparison between subjects and activities. The average EMG is the best method to describe the typical innervation input to an investigated movement or activity. A qualitative inspection of the “innervation behavior” within the movement cycle is an important clinical diagnosis that does not require MVC normalization (Fig. 52)!

Averaging without time normalization

For the analysis of innervation characteristics within the stretching/shortening cycle (reactive contractions < 180 ms) or reflex loops, any time normalization should be avoided because it may destroy the true time characteristics which can count in a few milli-seconds. An alternative concept is to average a fixed duration period before and after a certain event, such as first ground contact in jump testing, contact hit of the reflex hammer to test tendon reflexes or first angle change of a tilt platform to measure the muscle response to sudden ankle pronation/supination (see chapter Timing Analysis).

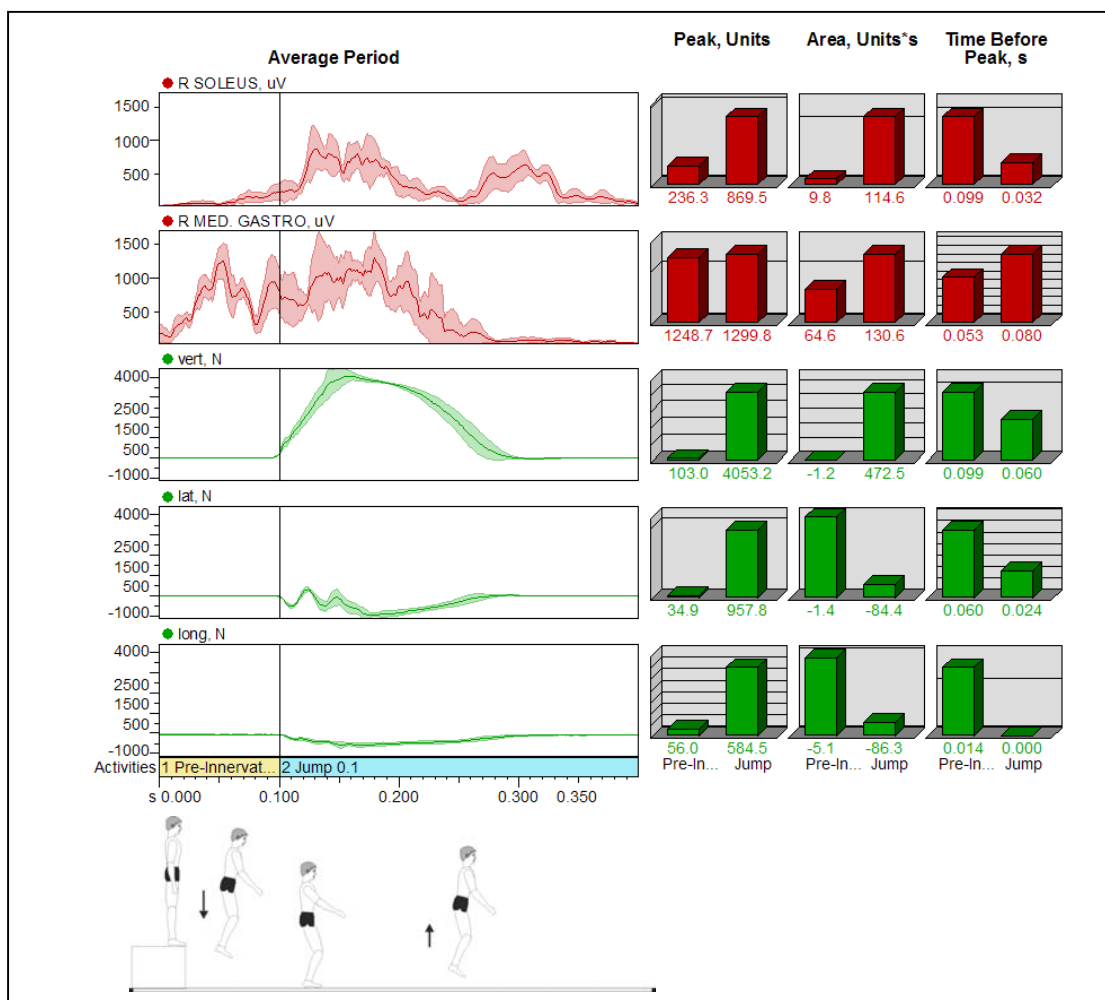

Fig. 53: Averaging without time normalization. A fixed interval before and/or after (blue activity section) a reproducible movement event (ground contact) is used as a standardized format for the averaging. For the drop jump on a force plate as shown above a fixed interval of 100 ms is selected to describe the pre-innervation phase (yellow activity section), a 400 ms interval after the ground contact is used to describe the EMG activity (red curves) and impulse (green curves) of the jump.

EMG Amplitude Parameters

Standard amplitude parameters

Like any other measurement curve, EMG traces can be calculated with standard amplitude parameters, such as mean, peak, minimum value, area and slope. The preliminary condition is rectification, due to the bipolar signal nature (Fig. 54).

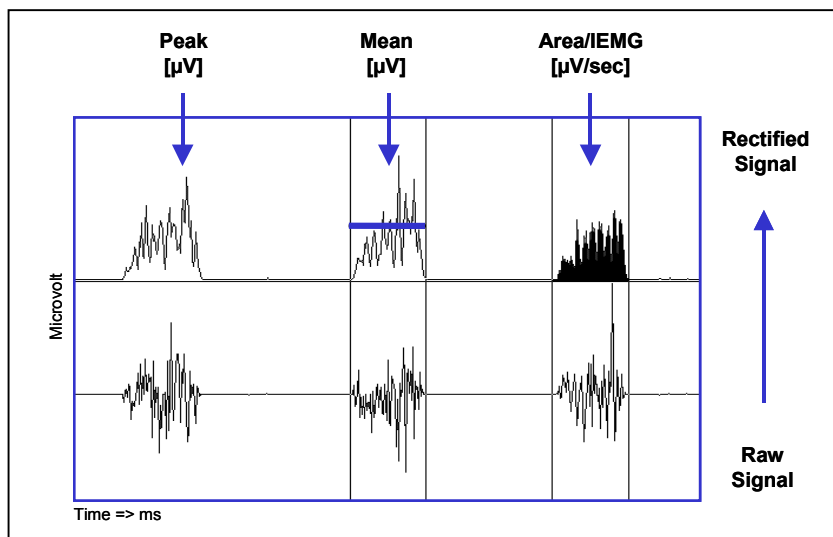

Fig. 54: EMG standard amplitude parameters based on the rectified EMG curve

The EMG **Peak** value is only meaningful for averaged curves because even for smoothed rectified EMG traces, it is still too variable. A reasonable modification of the single peak calculation is the **Average Peak** calculation: e.g. the first ten highest peak values within an analysis period are averaged to the average peak. The amplitude **Mean** value of a selected analysis interval is probably the most important EMG-calculation, because it is less sensitive to duration differences of analysis intervals. The mean EMG value best describes the gross innervation input of a selected muscle for a given task and works best for comparison analysis. The **Area** is the true mathematical integral under the EMG amplitude for a certain analysis period. Depending on the point of view, it has the benefit or drawback of being directly dependent on the time duration selected for an analysis.

IEMG means integrated EMG and in earlier days this term was often disused for analog smoothed EMG curves (using “an integration time” within analog filtering).

Based on the Mean value calculation, another modification is the **Input** % Value: In a first step the mean EMG values of all analyzed channels are summed up and the result is defined as 100 % EMG input. Now, in a second step, the percentage amount each channel shared to get this 100% is calculated (Fig. 55). This calculation is a kind of distribution analysis and can nicely be used to compare innervation ratios between exercises.

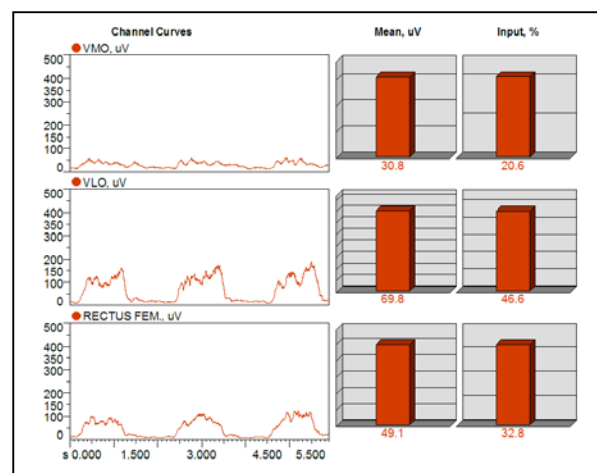

Fig. 55: The Mean value of an analysis interval is calculated for three muscles. All values are summed up and defined as 100%. The Input% calculates the percentage amount of each muscle within

EMG Frequency Parameters

Calculation of the frequency contents

Modern PC technology makes it very easy to use **Fast Fourier Transformations (FFT)** to analyze and estimate the frequency contents of EMG signals. In a model, a superposed EMG signal can be considered as a summation of sine waves with different frequency velocity (Fig. 56). The FFT algorithm can be described as a decomposition of the EMG signal to its underlying sinus contents. E.g. if the most dominant (large amplitude range) sine wave is recognized at 80 Hz, this EMG has a lot of power at this frequency. If this kind of power distribution analysis is done continuously over a certain Hertz range, a frequency distribution graph or **Total Power Spectrum** is created (see Fig. 31).

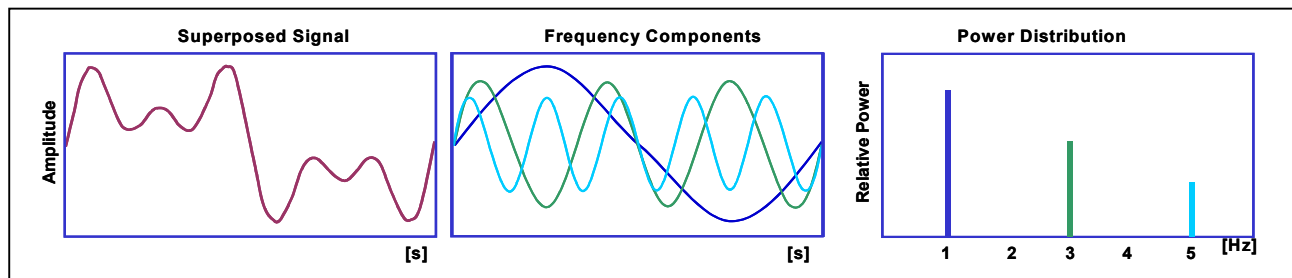

Fig. 56: Model of frequency related signal decomposition based on FFT. The signal on left side contains 3 underlying waves (middle): a sinus wave at 1 Hz, another at 3 Hz and finally one wave at 5 Hz. The power distribution (right) indicates Power of different magnitude at this frequencies. Adopted & redrawn from 3, p. 24

Analysis parameters of the Total Power Spectrum

The Total Power Spectrum can be calculated again by the following frequency parameters: **Mean Frequency** as the mathematical mean of the spectrum curve, **Total Power** as the integral under the spectrum curve and **Median Frequency** as the parameter that divides the Total Power area into two equal parts (Fig. 57).

Finally the **Peak Power**, the max.- value of the Total Power Spectrum curve can be used to describe frequency characteristics. Within applied EMG-frequency analysis the most important parameters are the mean and median frequency and their time domain changes in sustained contractions (fatigue studies).

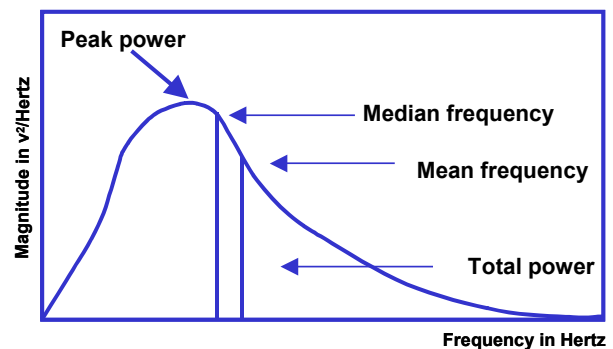

Fig. 57: EMG standard frequency parameters based on FFT calculations

Zero Crossing or Zero Turns

An alternative to the FFT based calculations is the simple counting of crossings through the zero line of the EMG signal. This **Zero Crossing** rate is highly correlated to the FFT based mean/median frequency and can be used as an alternative to FFT calculations which required considerable calculating time and PC-power. Today Zero Crossing has become less important and FFT based calculations are the preferred choice.

Timing Related Parameters

Time to Peak calculation

Another important class of EMG parameters addresses timing characteristics within the EMG signal and in ratio other biomechanical signals or movement events. The easiest one is the **Time to Peak** calculation, which is the duration from the beginning of the analysis period (or beginning of contraction) to the peak amplitude value. This parameter is important to e.g. describe characteristics of average curves (Fig. 58).

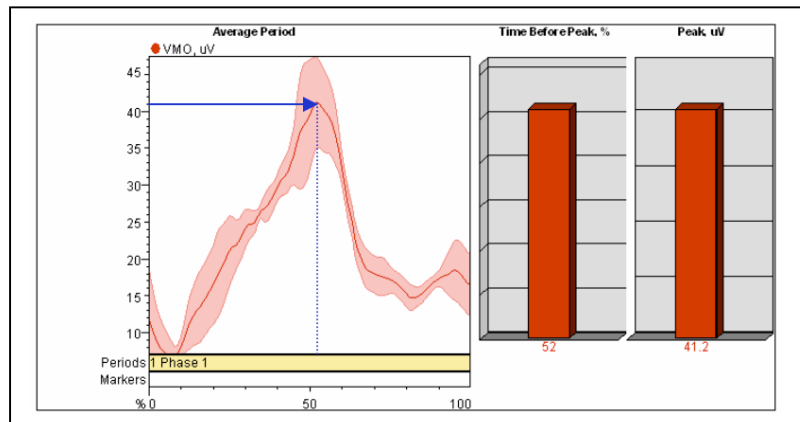

Fig. 58: Time to Peak calculation for an average curve. The beginning of the calculation period is the beginning of the movement cycle; the (time normalized) peak time point is an important parameter to describe average

Onset/Offset calculations

The main idea of **Onset** parameters is to calculate how long a muscle needs to turn on, how long it stays on and how much EMG is used within the onset period (Fig. 59). The most popular analysis is the **nerve conduction velocity** measurement, where an external stimulus is applied and the reaction time to the EMG onset is calculated. Based on the known distance between stimulus and electrode site, the conduction velocity is determined.

Another analysis class addresses the coordinative question “in which order the muscles start to fire”. Starting from a relaxed muscle position the **Firing Order** for a given movement is analyzed.

Finally **Onset pattern diagrams** can be derived, indicating at what time portion within an investigated movement a muscle is on or off. Early gait analysis concepts used it for multi channel EMG applications in average cycle plots (see Fig. 71).

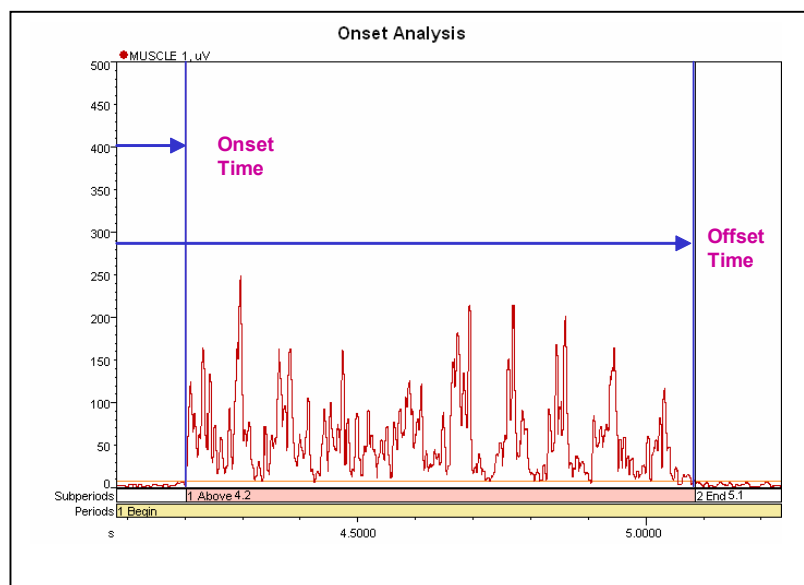

Fig. 59: Illustration of the Onset and Offset time period. Based on the beginning of an analysis period, a threshold criteria is applied to determine the Onset time of EMG. If the same threshold is passed again, the Offset time is reached

Thresholds Concepts to Define Subperiods

Threshold definition by multiple SD of EMG-baseline noise

The accuracy and validity of any Onset/Offset calculation depends on an appropriate threshold definition. It is the most sensitive point in this class of calculations. Several methods can be applied to define the onset and offset of muscle activity. The most popular approach calculates the standard deviation range of the EMG baseline before a certain activity. In the next step, a multiplication factor of this range is defined, typically a factor of 2 or 3. When the muscle activity exceeds the double or triple SD range, the muscle is defined to be “On” or activated. Because single spontaneous spikes can easily exceed the SD range, it is useful to define a minimum time (minimum subperiod duration) that the EMG signal has to constantly stay over the threshold to be accepted as “On” (e.g. 50 ms). The same is valid for the offset of the signal, to avoid that single random amplitude gaps trigger the “Off” of muscle activity.

Even if very popular, the SD based threshold definition can be difficult to set up for valid and repeatable results. The SD noise can largely vary between trials and subjects, which makes it difficult to define a fixed multiplication factor for all trials. Another possible “problem” is that modern EMG amplifiers are so noise free that the multiplication factor has to be increased to 8 times or higher to give reliable results (Fig. 60):

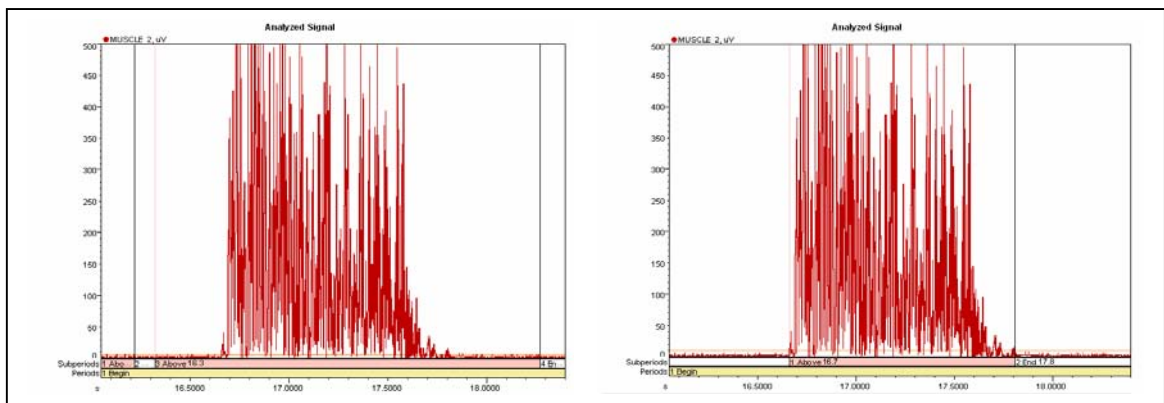

Fig. 60: Adjustment of the SD multiplication factor to determine a reliable threshold level for EMG onsets/offsets. The threshold on left side is set to 3 standard deviations and fails to detect a valid activation (marker lines and pink bars). The noise free baseline requires an increase to 8 times SD to detect the contraction onset/offset correctly.

Threshold definition by local peak value

An alternative solution of threshold definition would be a percentage amount of the local peak activation found within the analysis period, e.g. 5%. This peak setting produces much more reliable threshold settings and is independent from the baseline characteristics and variations.

Threshold definition by a fixed value

Another alternative would be to define a certain microvolt level or better, a certain percentage value for MVC normalized recordings.

Whatever method is selected, it is absolutely necessary to graphically check the validity of the threshold setting results and Onset periods.

EMG To Force Ratio

The relationship between EMG input and force output

EMG activation is the preliminary condition for any force development and one can expect a very close relationship between both measures. Indeed, there is a very high correlation between both parameters, but unfortunately it can greatly vary within its characteristics. The typical case is a curvi-linear relationship: at higher force portions proportional more EMG is needed to increase force (Fig. 61):

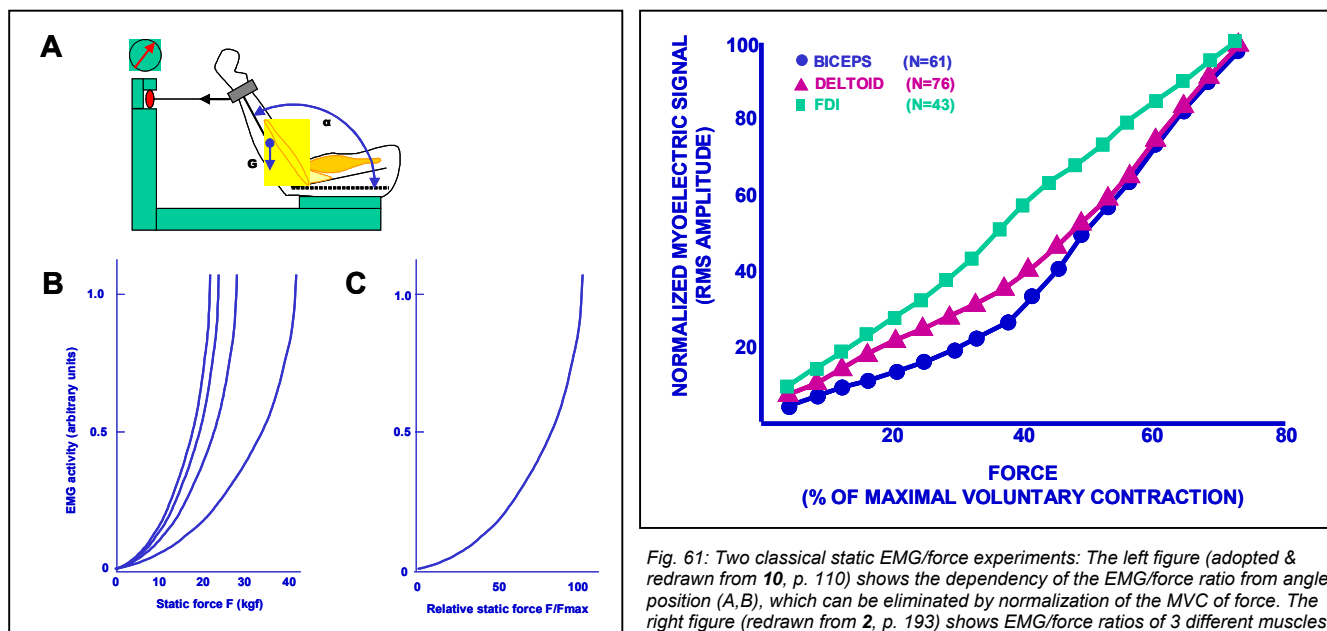

Fig. 61: Two classical static EMG/force experiments: The left figure (adopted & redrawn from 10, p. 110) shows the dependency of the EMG/force ratio from angle position (A,B), which can be eliminated by normalization of the MVC of force. The right figure (redrawn from 2, p. 193) shows EMG/force ratios of 3 different muscles for MVC normalized EMG and force output data

For certain conditions within static force testing (both EMG and Force are normalized to its maximum value) some (smaller) muscles tend to show true linear EMG-Force relationship (Fig. 61, right diagram). The investigation of such relationships is important if EMG has to assist torque calculations within biomechanical models. Under a more practical point of view, e.g. within clinical treatment procedures, one can safely derive that with any EMG increase the torque and compression force around a joint increase in a similar fashion.

The EMG-Force ratio can be used to determine the neuromuscular (training) status of a muscle. Within static contractions with constantly increasing force output (ramping) well-trained muscles show a clear right shift of the ratio, atrophic or very untrained muscles show a left shift (Fig. 62).

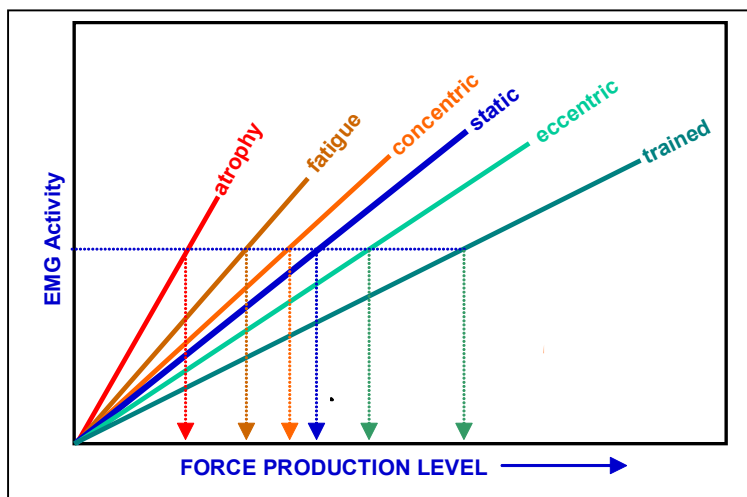

Fig. 62: Schematic EMG/force relationship in ramp contractions. Depending on the muscle condition and training status the ratio can alter. Trained muscles need less EMG for a given force output than atrophic or fatigued muscles.

EMG as a Biomechanical Method

The role of EMG within biomechanical studies and setups

The world of biomechanical measurement method can basically be separated to 4 major areas: Anthropometry, Kinematics, Kinetics and Kinesiological EMG (Fig. 63). The important role of EMG is the objective evaluation of the neuromuscular activation within any activity. Unlike the other areas, EMG is a without a serious competitive method within its class.

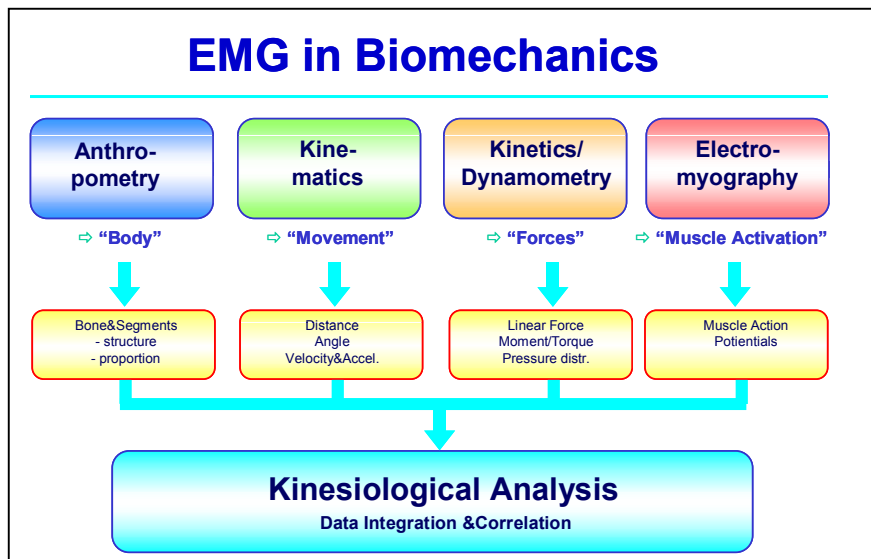

Fig. 63: The 4 major areas of biomechanical measurement methods

The important starting point is the proper selection and combination of methods that can address a certain topic. Starting from a problem you observe with your subjects or patients or the desire to achieve a better understanding of the physiological conditions within any activity, you formulate expectations or hypothesis on that particular topic. Usually it is easy to convert assumptions to categories of questions. In the next step you need to decide which biomechanical method can best detect the processes related to your questions. The selection of a correct biomechanical sensor or class is very important.

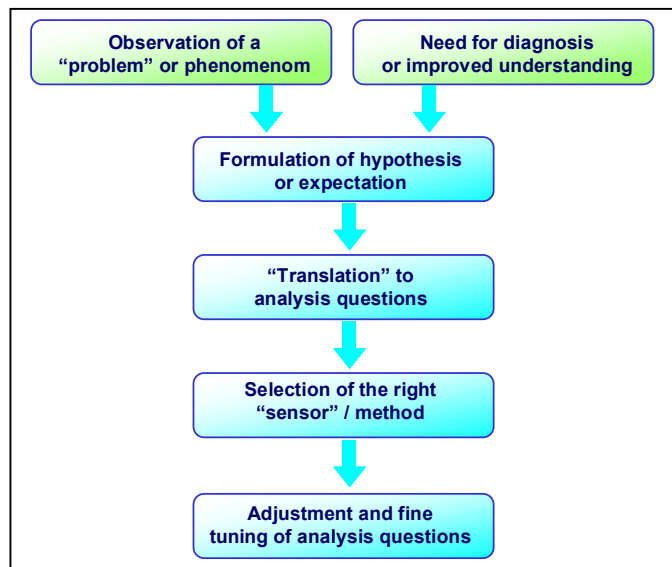

Fig. 64: Analytical questions are the basis of proper sensor selection within biomechanical methods

E.g. EMG cannot answer how strong (in Newton) a muscle is, and the other way around, force measures cannot answer if a muscle fires correctly. Finally, within each category of biomechanical sensors, several sub-classes of analysis questions can be answered. The following chapters explain in detail what types of analytical questions you can "ask" EMG and how to use them as an analysis concept.

EMG Analysis Questions - Overview

Types and scaling of analysis questions

There are basically 5 major categories of analysis questions that EMG can address and (very precisely!) answer:

Level of question	Type of answer	Type of scaling
1) Is the muscle active?	Yes/No and On/Off	Nominal
2) Is the muscle more or less active?	Ranking between tests in qualitative terms	Ordinal
3) When is the muscle on/off?	Onset/Offset calculations, firing orders	Metric
4) How much is the muscle active?	Expressed in e.g. % MVC	Metric
5) Does the muscle fatigue?	Slope calculation of EMG parameters	Metric

It is important to note that with increasing question level, the complexity of EMG analysis increases too. If a clinician needs a quick check if a neurological patient can voluntarily activate a muscle, a one channel raw EMG recording that requires 1 minute preparation time will directly answer his question. On the other hand, if the coordinative quality within complex movements needs a deeper investigation, one may decide to use a 16 channel recording and amplitude normalization to MVC that may require 1 hour preparation time.

EMG can only answer its specific categories of questions. Like any other biomechanical method, it acts like a lens by focusing on one selected subsystem or component of a very complex overall biological system. Muscles are the “motors” (or brakes) of locomotion, but by their nature they only receive and operate reflex based or CNS driven commands. EMG of a muscle alone can never answer a “**Why?**”

This makes any interpretation of EMG findings very demanding and requires fundamental understanding of the sensi-motor system. Be aware that any neuromuscular finding from the “Active Motor System” is also influenced by processes of other biological subsystems (Fig. 65). The challenge is to re-integrate a certain finding from one sub-system to the entirety of the human body. A single biomechanical finding, even if measured accurately, is worthless if not integrated to the total system.

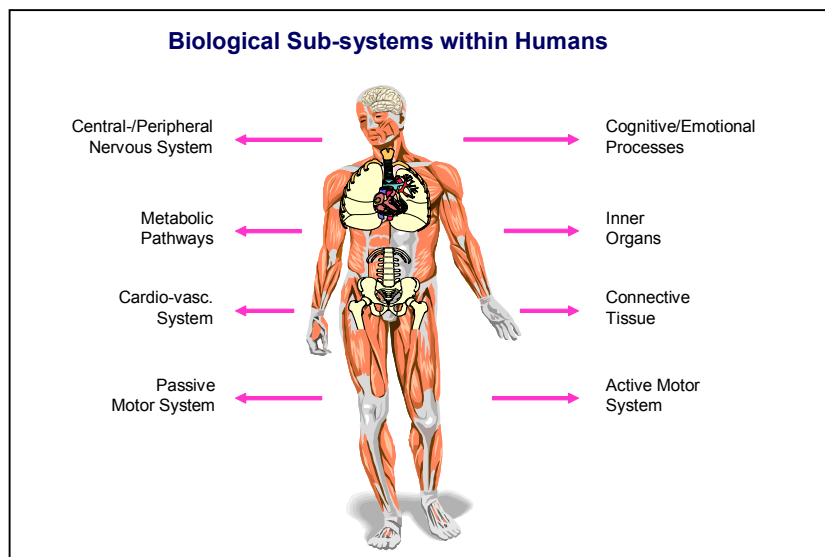

Fig. 65: Biological sub-systems that act in dependency to each other. A single finding within a selected subsystem does not reflect the whole system

EMG Analysis: On/Off?

Question level 1: Is the muscle active?

This category of questions is directly answered by observing the raw EMG trace of any activity. It is answered on the nominal level by yes/no or on/off. Caution is needed to check that the quality of the EMG baseline allows a clear identification of active EMG. Noise may not be interpreted as “increased tonus”.

The relevance of this fundamental question may be underestimated or misunderstood. Not only for neurological therapists asking if the patient can access to a certain muscle, but also for training professionals, this basic question can quickly receive relevance. E.g. the incorrectly assumed “postural” role of the M. gluteus maximus in regular upright standing, or the lumbar spinal/pelvic “stabilization” function of the M. rectus abdominis, two fundamental misunderstandings derived from pure functional anatomical considerations can quickly be cleared by simply asking and measuring, if these muscle are active or not in these given tasks (Fig. 66).

A healthy well organized muscle in regular conditions turns off if it is not needed anymore. If it still stays on, it is an indicator for active muscle spasm, reflex induced (e.g. pain) hypertonus, joint instability or behavioral disuse (stress, bad muscle coordination).

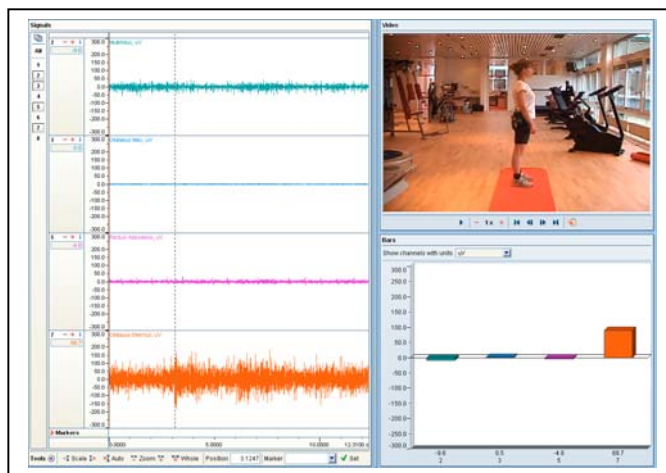

Fig. 66: EMG on/off-analysis of a regular upright standing / posture task. The multifidii (ch. 1) and internal obliques (ch. 4) show significant EMG activity (=on), whereas the gluteus maximus (ch. 3) and rectus abdominis (ch. 2) are “off”. The same finding is found on instable ground or one leg standing – indicating which muscles really contribute to postural stability

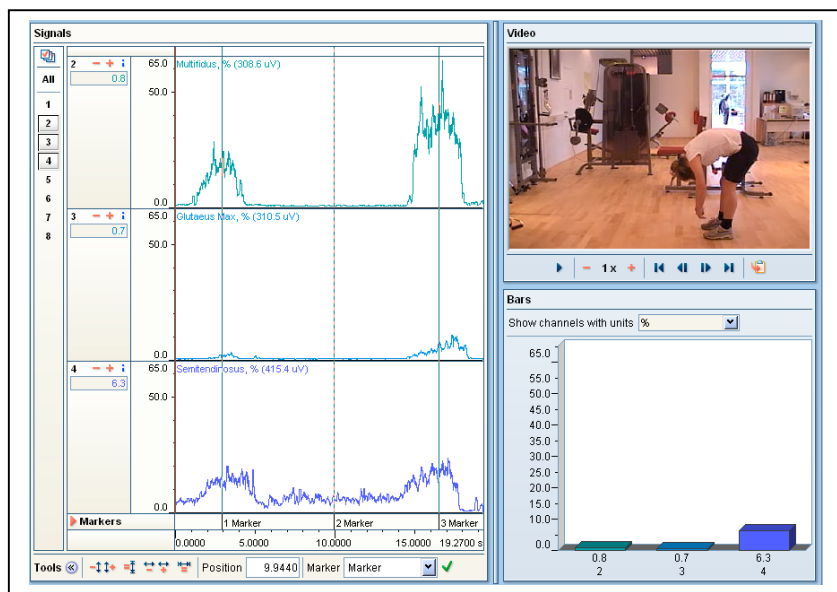

Fig. 67: The flexion-relaxation phenomenon. When slowly bending forward from an upright position, the back muscles (ch.1 multifidii) and hip extensors (ch. 2 gluteus maximus) turn off at the most flexed position (dashed vertical line and video picture). The limb momentum is held by passive structures like ligaments. When slowly extending back, both muscles start firing again. Other synergists (ch. 3 hamstrings) are active all the time. Low back pain patients can lack this innervation silence due to dysfunction or pain.

EMG Analysis: More / less?

Question level 2: Is the muscle more or less active (in comparisons)?

The questions type “more/less” requires at least one comparison condition, like the EMG of the left and the right side, the pre-post test or subject to normative curve comparison. The question type addresses a qualitative answer where quantities are ranked on an ordinal (instead metric) level.

Typical ordinal amplitude scales are:

No activity	absent	minus	test with lowest activity
Moderate	inadequate	plus	ranking of test in between
High	excessive	2 x plus	test with highest activity

From a clinical and practical point of view the qualitative analysis (and interpretation) of EMG amplitudes is the probably most important and useful way of analyzing patient data. As discussed earlier (see “Drawbacks of MVC normalization”) patients typically cannot perform MVCs for amplitude normalization, and other normalization methods do not really create a benefit.

The question category *more or less* receives quantitative character if it is used for the same muscle and subject without removing the electrodes between trials. Especially for subjects or tests where amplitude normalization is not suitable, it would be the major leading analysis question: “what is the difference in activity between two contraction conditions?” Within this design, at any time one can safely express the microvolt difference in percent, e.g. test 1 revealed 35% less mean EMG than test 2. Within qualitative analysis it is helpful to present data as curves, because data reduction to a single amplitude parameter may mask important information of the muscle pattern itself.

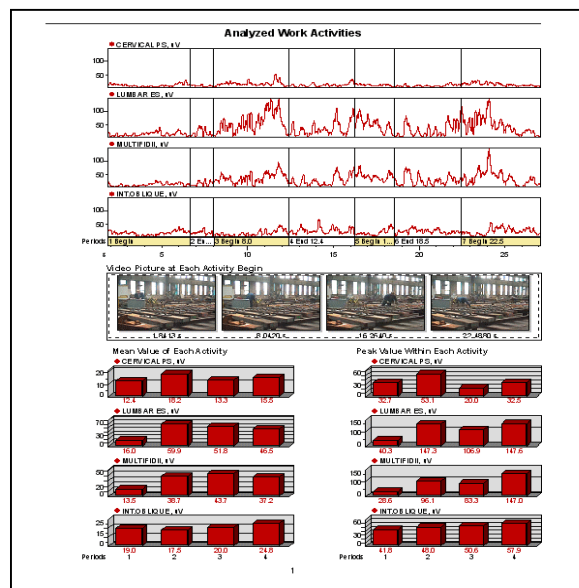

Fig. 68: Video-based EMG analysis of 4 different work activities (yellow intervals) measured in microvolts. Where is more or less EMG?

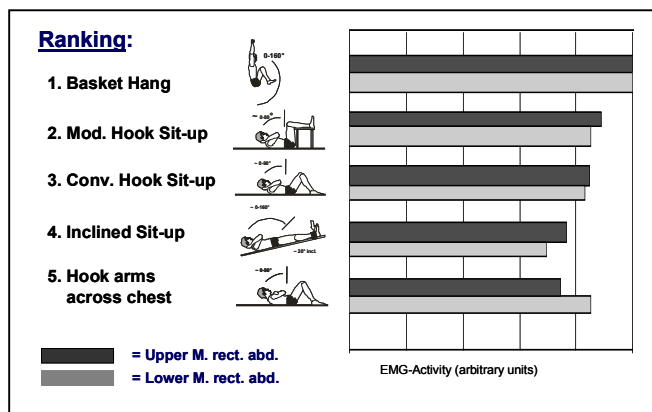

Fig. 69: EMG analysis of 5 abdominal exercises, ranked by the highest EMG found (basket hang) and scaled in arbitrary units

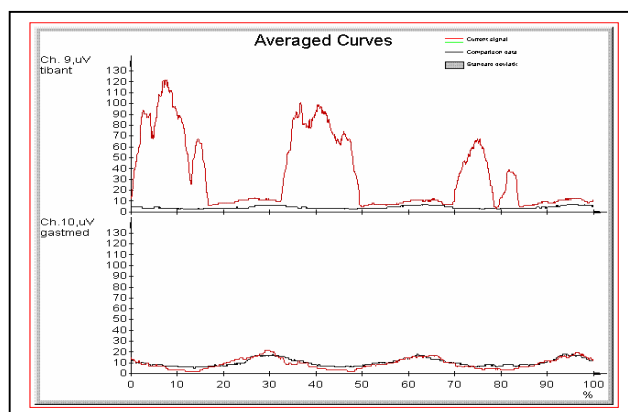

Fig. 70: Qualitative EMG analysis of the tibialis anterior (upper trace) and gastrocnemius medialis (lower trace) in left/right comparison of a spastic patient performing 3 squats. The more/less analysis focuses on side comparison and constancy between repetitions.

EMG Analysis: Muscle Timing?

Question level 3: When is the muscle on/off?

Based on certain threshold criteria that defines when a muscle is “On” (see chapter “Timing Related Parameters”), the timing characteristics of a muscle within a certain movement event or in comparison to other muscles (Firing Order) can be calculated on a metric time scaling base. This analysis type does not require any amplitude normalization and is therefore a helpful analysis strategy in patient measurements.

A popular example is the On/Off timing pattern of muscle in the gait cycle, which allows a good overview of the neuromuscular activity pattern in normal and pathological walking (Fig. 71). One may question if the data reduction to “On/Off” activity bars properly reflects the neuromuscular coordination, since the threshold definition for muscle onset can be critical and invalid (“see chapter Threshold Definition by multiple SD”).

Another type of investigation (Fig. 72) addresses muscular reflex loops, e.g. the muscle response of the lower leg muscles in unexpected pronation of the ankle joint evoked by controlled tilt platforms (“how long does the muscle need to counter-react the pronation?”).

Within the analysis of lumbar segmental stabilization timing characteristics of the involved stabilizers (Fig. 73) are an important measure for correct or insufficient “Core Stabilization”.

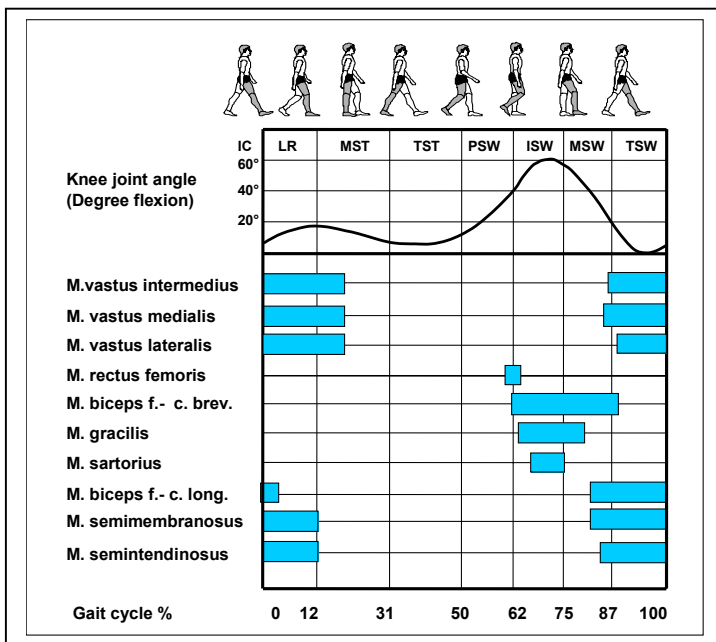

Fig. 71: On/Off timing pattern of ten lower leg muscles within a gait cycle. Blue bars indicate when the muscle is active. Adopted and modified from 8

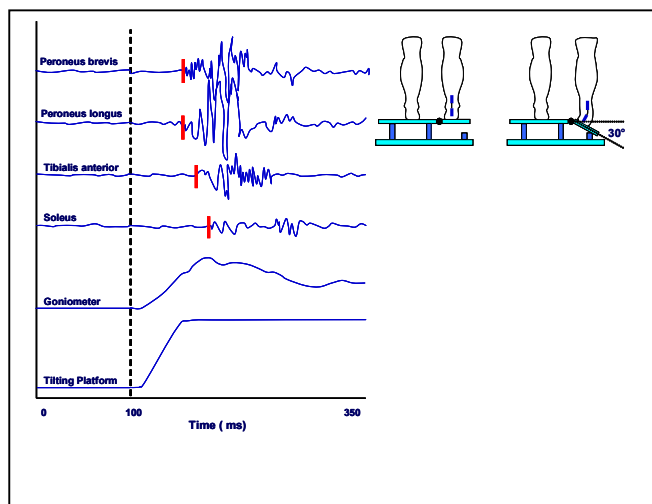

Fig. 72: EMG onset analysis on a tilting platform. The reflex induced onset of ankle stabilizers at unexpected tilt (dashed line) is calculated. Adapted and redrawn from Rosenbaum et al.

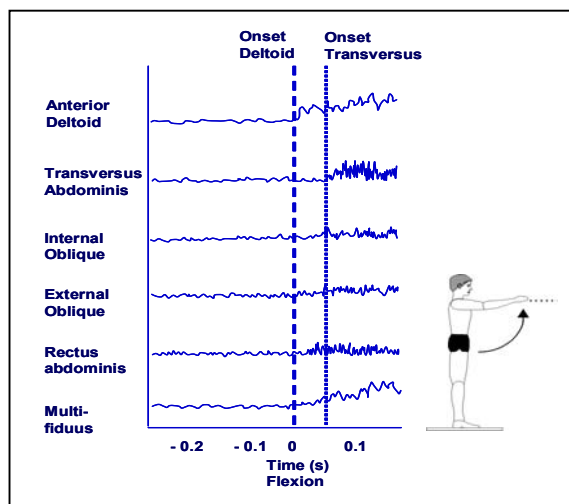

Fig. 73: Delayed innervation (narrow dash line) of lumbar segmental stabilizers (Transversus abdominis, Multifidus) in ratio to the onset of the deltoid muscle (wide dash line) in rapid shoulder flexion done by a low back pain patient. Adapted & redrawn from 9, p. 62

EMG Analysis: How Much Activity?

Question level 4: How much is the muscle active?

On this question level the EMG amplitude has to be calculated on a metric scale, giving a number to the question “How much?” This question cannot be answered by the original microvolt scaling, because the original electrical muscle activity is influenced by the local given detection condition that can greatly vary. To overcome this external influence, a rescaling to percent of a certain reference value is applied - preferred to the maximum EMG signal available in optimal static contraction condition (see The concept of MVC-normalization).

The question *How much EMG* basically addresses the interest to understand how much work or effort a certain muscle has to share in a certain exercise or task. This kind of evaluation is important to understand the effect of treatment and training exercises (Fig. 74) and reveal their character of being low, submaximal or maximal in demand: e.g. efficient strength training exercises need a innervation level of at least 40 – 60% of MVC to create a positive effect strength increase due to supercompensation (muscle hypertrophy in healthy subjects).

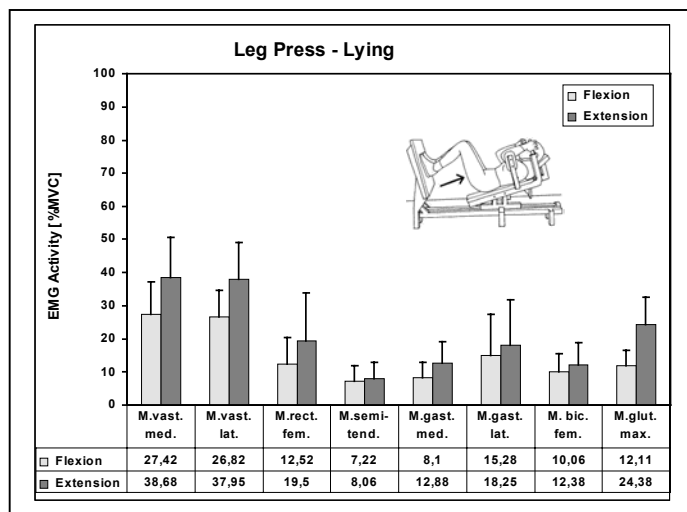

Fig. 74: Muscular innervation profile of 8 hip/leg muscles in the horizontal squat movement. Data shows the MVC normalized mean EMG of 6 extension and flexion periods measured for a group 10 subjects at 40% of the individual one repetition maximum.

Ergonomics may need to understand the neuromuscular demand of a given work activity to improve techniques and conditions to lower stress and strain on employees. The design of work tools, seats and other work space related conditions/devices will benefit from the analysis of the neuromuscular effort.

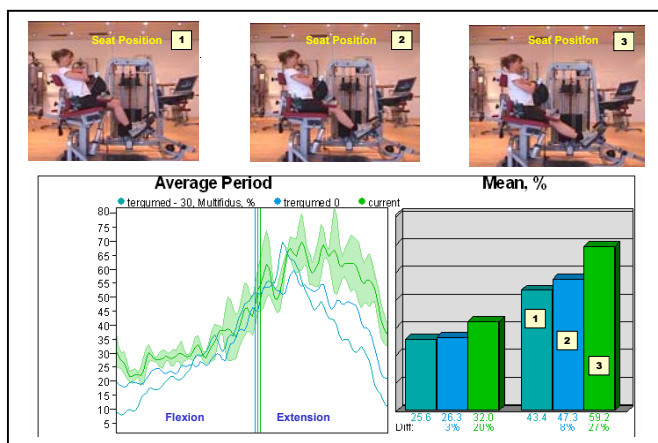

Fig. 75: EMG efficiency analysis for 3 different seat positions based on the MVC-normalized average curve of the multifidus muscle in a sequence of back flexion/extension cycles. At a given load (60% Max.) seat position 3 shows the highest EMG innervation.



Fig. 76: Ergonomic EMG analysis of two shoulder muscles (upper trace -: trapezius p. desc; lower trace - deltoideus anterior) in a work task within a steel production process. The MVC normalized signal show the muscular demand in ratio to the given video picture

EMG Analysis: How Much Fatigue?

Question level 5: Does the muscle fatigue?

Within static submaximal contractions both amplitude and frequency based analysis parameters show time domain changes due to muscular fatigue (2). The classical test requires a constant load level at a well defined angle position/muscular length. Due to recruitment of motor units, the amplitude shows an increase, whereas the frequency based mean or median frequency of the total power spectrum show a decrease over contraction time. The latter ones decline because - besides other reasons - the conduction velocity of the motor actions potentials on the muscle membrane decreases.

This causes a left shift of the Total Power Spectrum towards lower frequencies (Fig. 77). The regression coefficient of the median or mean frequency slope towards lower frequencies can be used as a non-invasive fatigue index for the investigated muscle. It is assisted by the intercept which is the crossing point of the slope and the Y-axis.

The study of local muscle fatigue effects has two important applications. First, it can be used to identify weak muscles. The most famous application of frequency shifts ("Muscle Fatigue Index", 3) is in the analysis of low back pain patients. Second, it can be used to prove the efficiency of strength training exercises. Since FFT based calculations – from a mathematical point of view – need signal stationarity and a Gaussian distribution of samples, it is more the amplitude increase and its underlying motor unit recruitment that is used in dynamic movement patterns, such as strength training exercises.

Fatigue has to be considered as a very important control parameter for muscular (hypertrophy) training! Training induced short term fatigue is the preliminary condition for muscle growth. Some fatigue tests show opposite findings: the frequency shifts up and/or the amplitude falls down. This phenomenon is less frequently reported in literature and may be explained with migration of muscle activity within synergists and reduction of co-activation within antagonists.

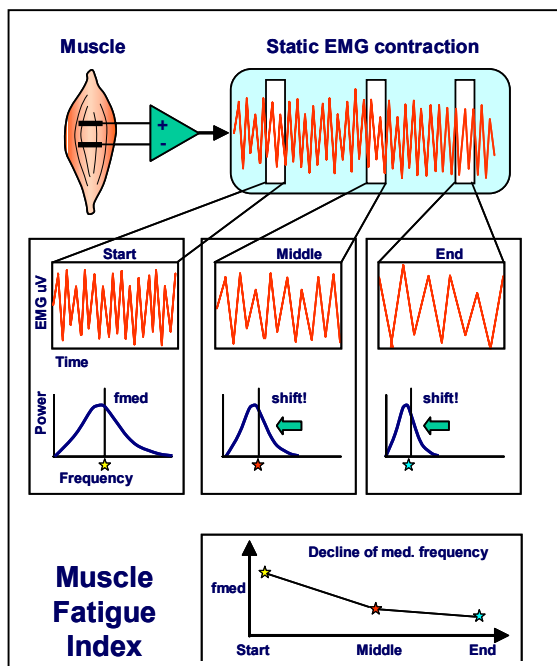
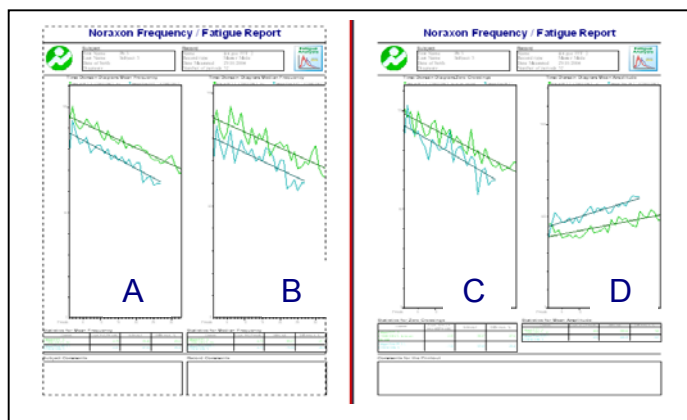

Fig. 77: Schematic illustration of the frequency shift towards lower frequencies in sustained contractions and calculation of the muscle fatigue index. Adopted and redrawn from De Luca



Fig. 78: Typical test arrangement and findings for static back endurance tests: Median (A), Mean Frequency (B), Zero Crossing (C) and Mean Amplitude (D), slope of a trained (green) and untrained (blue) subject, measured for the multifidus muscle.



EMG Analysis: Movement Coordination

Conceptual aspects to assess muscular coordination

The investigation of muscular coordination can be performed on all 5 analysis levels discussed before. But it requires at least two involved muscles. Typically, all important muscles around a joint (agonist, antagonist, and synergists) or all muscles within a “muscle chain” (e.g. back/hip muscles from cervical spine to thigh) are measured. The judgment of “good” or “bad” coordination needs very precisely formulated criteria.

Examples are:

- Symmetrical innervation of synergists
e.g. the Mm. vasti at the quadriceps group
- Synchronized firing order of muscles
e.g. within a muscle chain or muscle ring
- Feed-forward innervation of stabilizers
e.g. lumbar segmental stabilizers
- Appropriate co-innervation of antagonists
e.g. low and late

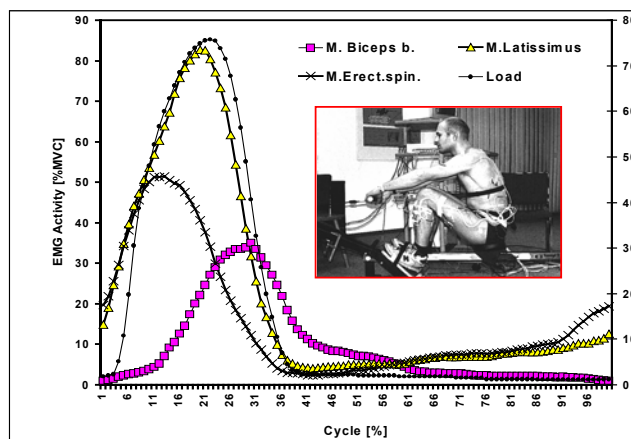

Fig. 79: Coordinative EMG analysis based on MVC normalized average curves (N=10, top rowers) over a sequence of 8 rowing cycles. The pattern analysis allows a precise description on how much and when a certain muscles fires within the investigated movement.

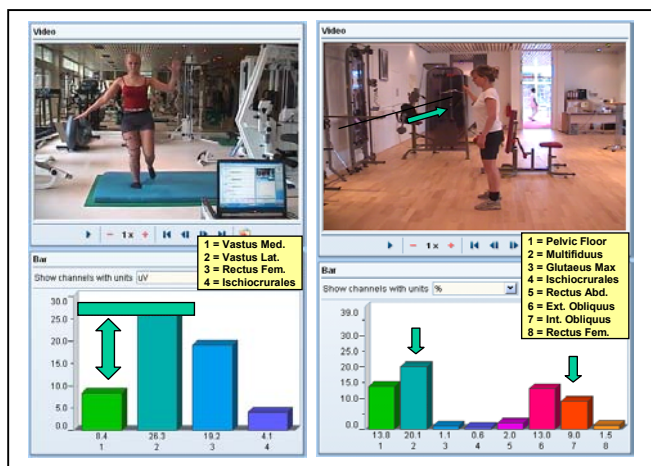

Fig. 80: Two clinical examples based on microvolt scaled RMS EMG analysis of muscle groups at video picture position. The left picture indicates EMG imbalance between the vasti within a knee stabilization task. The right pictures proves the appropriate innervation of lumbar stabilizers (multifidus, internal obliques) within a shoulder training exercise at a cable machine

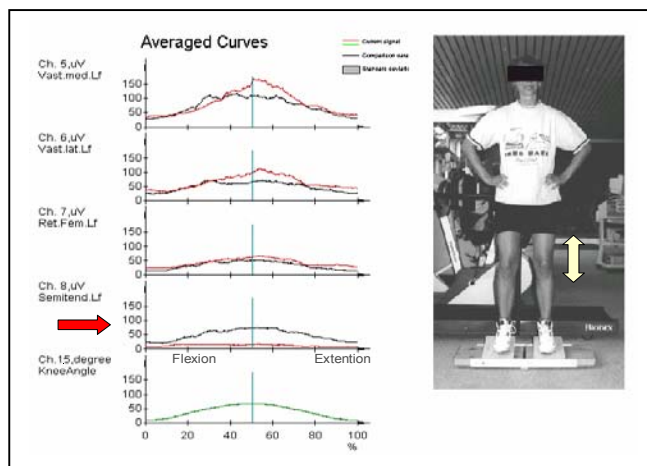

Fig. 81: Left/Right comparison of average curves (left side=black/injured) of 4 knee muscles within a free squat movement sequence (6 reps) of a patient 4 weeks after ACL-rupture and surgery. Due to mechanical knee instability the flexors (ch. 8 hamstrings) act like agonists (black curve). Typically no innervation (red curve) is visible for this muscle group/exercise

Design of EMG Tests: Need of Standardization

Factor that influence a test exercise

One of the most important strategies to prepare a meaningful EMG analysis and interpretation is the standardization or control of factors that influence a test position or movement. Without understanding and controlling the movement characteristics itself it is nearly impossible to interpret EMG data. A general (scientific) requirement is to be able to reproduce a test. The most important factors that have to be considered and standardized are:

Factor	Comments
Angle position in static tests	The angle and muscle length directly influences the EMG amplitude because the active muscle migrates below the electrodes and muscle mechanics change with different sarcomere – distance (besides other biomechanical aspects)
Range of motion (ROM) in dynamic tests	In analogy to the previous factor, a varying range of motion significantly increase the variability of findings and needs an appropriate standardization
Movement velocity in dynamic tests	Any repetition cycle means constant acceleration and braking, higher velocity means increased acceleration and more motor unit recruitment per time, which finally results in varying overall contraction times and innervation levels
Load or resistance	Without the understanding of a given load condition or the lack of repeatable resistance, it is not possible to perform e.g. test-retest designs or fatigue studies or other EMG test to test comparisons
Duration/Repetitions In static or dynamic tests	Beyond 30% MVC innervation intensity, the static contraction duration or amount of dynamic repetitions has to be considered as a strong determining factor of influence (e.g. fatigue)
Preliminary status e.g. fatigue	The metabolic and central nervous conditions and also the time of day may be considered as a factor of uncontrolled variability!

Guideline: Keep as many factors as possible constant or controlled by other measures:

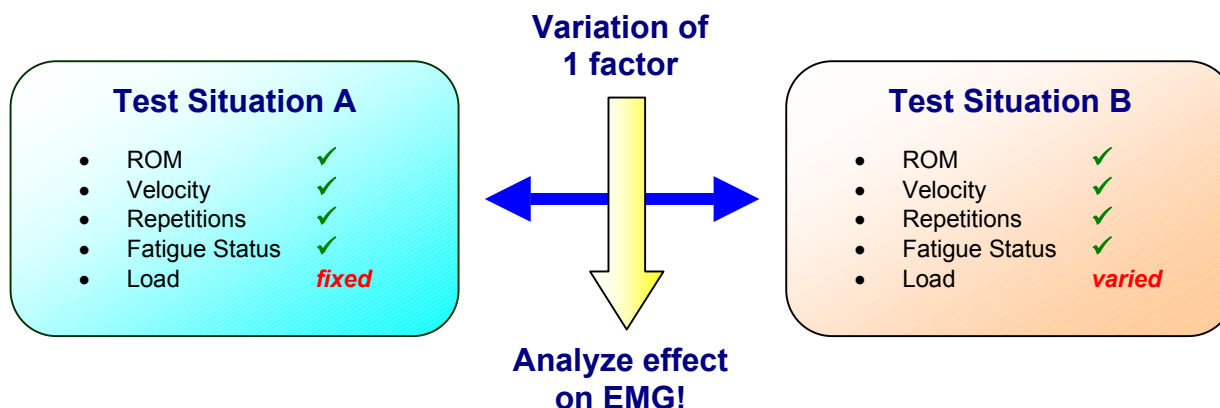

Fig. 82: Example of optimal test standardization. All factors except one are kept constant

Recommendations for Test Standardization

Strategies to standardize tests

Load

- Use the whole body or body segments as a static resistance
- Use external weights to standardize load
- Use a tilt platform or two body scales to control the weight distribution in squat exercises (Fig. 83)
- Use force load/torque cells for varying force output

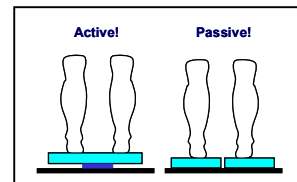

Fig. 83: Equal weight distribution by using two scales or a tilting plate

ANGLE/ROM

- Use belts to arrange a good fixation of body segments
- Use goniometers or inclinometers to monitor the ROM in free functional movements
- Use a “grid mirror” (Fig. 84) for free functional movements to standardize the ROM
- Use training machines to best control ROM (Fig. 85)

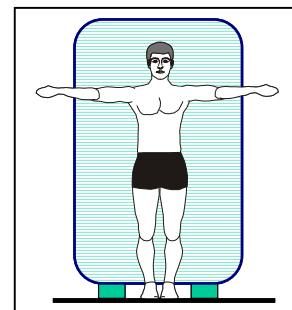

Fig. 84: Standardized ROM by using mirrors with grid lines

VELOCITY

- Use a metronome to standardize contraction velocity or step cadence
- Consider treadmills or isokinetics for constant speed

DURATION

- Use fixed contraction intervals
- Count repetitions
- Limit repetitions at high intensities

PRELIMINARY STATUS/CONDITIONS

- Same time of day!
- Best to select a non-fatigued condition and warm up subjects
- Constant room temperature

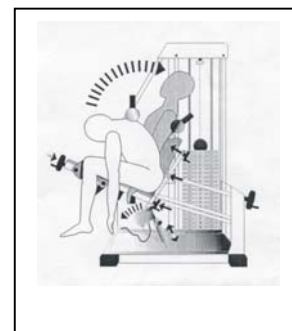

Fig. 85: Standardized ROM, body position and load by machines

GENERAL

- For quick evaluations prefer static tests against defined resistance
- Use isokinetics devices if very high standardization is needed
- Use random orders for multiple exercise to avoid systematic errors
- Try to only change one test factor between test comparisons
- Single joint exercises have less variability, use isolation techniques to study certain muscles within muscle chains

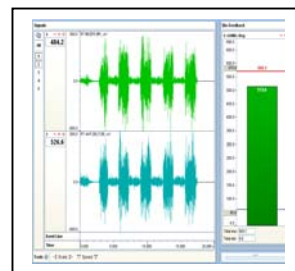

Fig. 86: Control of any movement parameter by biofeedback bars and predefined ranges

Examples for test standardization levels:

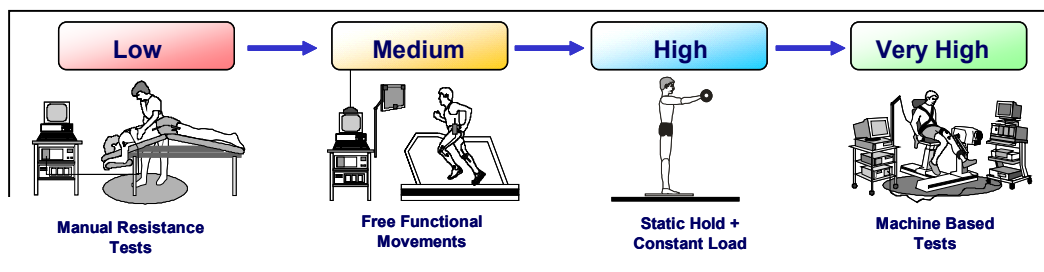

Fig. 87: Different levels of standardization dependent on the general test condition





EMG Triggered to Movement

Kinesiological EMG needs a trigger to movement

Any meaningful interpretation of EMG needs a clear understanding of the movement or activity that produced an EMG finding. Especially the contraction position (joint angle or muscle length) or contraction phase (e.g. extension/flexion) is important to determine. The ratio to movement phases and positions is typically arranged by event markers. Movement events are:

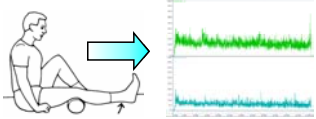
- Movement start and end
- Point of return within repeated movement cycles
- External stimulation within evoked potential tests
- Physical provocation to test muscle reflex responses
- Heel strike and toe off in gait cycles

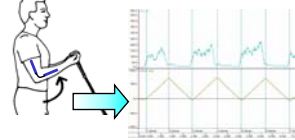
The following strategies to trigger movement events are established in kinesiological EMG setups:

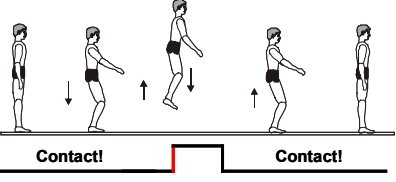
<p>Test within a reproducible static joint/ position</p>	<p>Simplest and easiest way to determine a movement position - no special marker or trigger routines are needed!</p>	
<p>Add manual marker lines in real-time</p>	<p>While recording, place manual markers to your record to indicate start and end of a movement phase - for slow movements only!</p>	
<p>Use synchronized video imaging to place event markers</p>	<p>Regular or High Speed video can be synchronized to EMG recordings and allow event definition</p>	
<p>Use goniometers, inclinometers or accelerometers on subject or built-in machines</p>	<p>Mobile sensors can be attached to the subject and will be recorded together with EMG</p>	
<p>Apply foot switches</p>	<p>Foot switches are mounted below the feet in gait analysis or contact plates are used in jump testing</p>	
<p>Use force plates or contact plates</p>	<p>The ground reaction force signal and contact mats are a very good indicators of ground contact</p>	

Period Definition For Analysis

The concept of periods and sub-phases

Event and marker lines define the ratio of EMG to the movement. In the next step they are used to define analysis periods. This step called period definition has several levels of complexity and styles. The easiest case would be that the whole record is used as an analysis period, the most complex one would create sequences of analysis periods with internal sub-phases like in gait analysis. Numerous modes exist between those two extremes, but the major categories are:

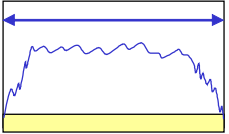
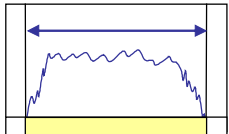
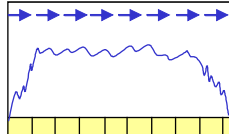
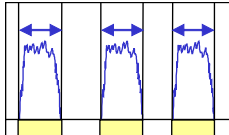
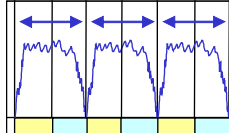
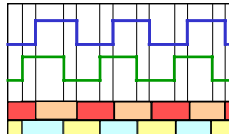
Period Definition	Remarks	Illustration
Whole record	The start and stop of recording is arranged so that the complete record will be calculated as one period	
A single period selection within a record	One period, selected by two markers or a mouse-marked area will be used as an analysis period. Allows the user to select a certain portion of interest within a record	
One period with a fixed step sequence of sub-phases	Within one selected analysis interval, a sequence of sub-phases going from the beginning to the end of the interval is used Typically used in static fatigue tests for the analysis of time domain changes	
Several periods within a record	Within a sequence of markers indicating the beginning and end of an activity, certain periods are selected for analysis. This mode allows, e.g. the comparison of activities recorded within one record	
Several periods with sub-phases	Within each period two sub-phases like stance-swing phase in gait or extension-flexion phase in free movements are determined	
Several periods with several sub-phases	Based on two trigger signals, sub-periods are defined: typically application is bilateral gait with left – right foot switches and side comparison	

In repetitive movement sequences like gait or knee flexion/extension the periods can be averaged before amplitude and timing based analysis parameters are calculated (see Averaged EMG/Ensemble Average).

Comparison Analysis

Comparisons as the key for all meaningful interpretation

Due to its relative amplitude character which is influenced by local detection conditions and the lack of normative curves or activation levels, the comparison of EMG findings is the most important strategy to analyze and interpret EMG data. Whenever you plan an EMG experiment or test, try to also plan reasonable comparison conditions right from the beginning. It is especially helpful to compare EMGs from the same muscle site in different movement phases, portions of the record or test activities: These analyses don't require any amplitude normalization (see Analysis question level 2: more or less). It is probably the most important EMG design at all.

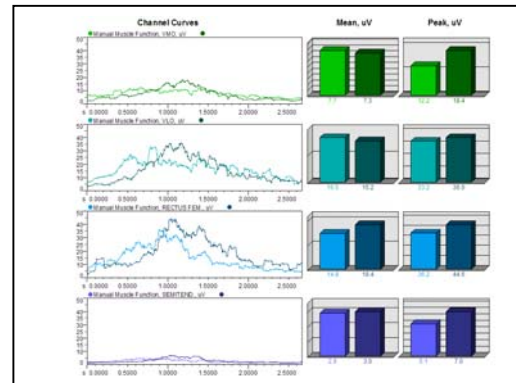

Fig. 88: Easy comparison analysis: two signal portions (e.g. from different tasks) are shown in an over-plot and the differences are analyzed

Comparisons Designs

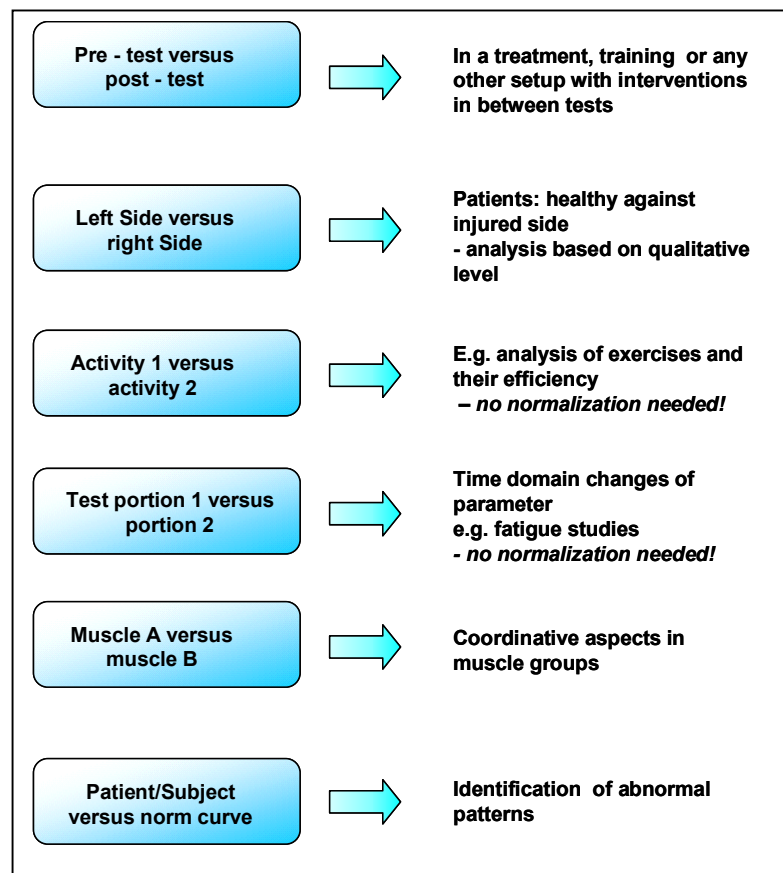

Fig. 91: The major comparison designs used within kinesiological EMG studies

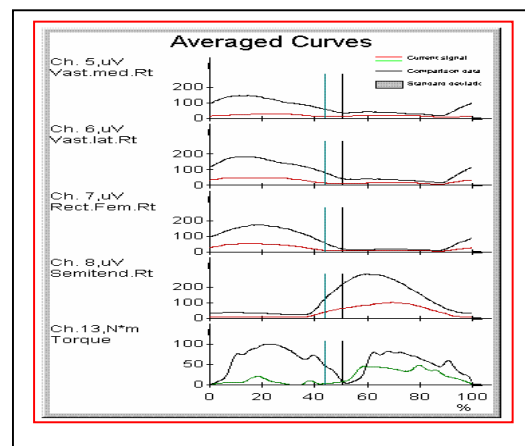

Fig. 89: Side comparison within isokinetic testing, based on averaged curves, with healthy and injured (red) side

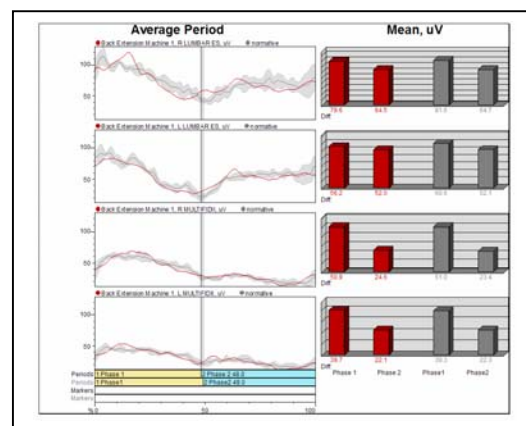

Fig. 90: Comparison of patients or subjects findings to normative curves, based on time normalized averaged curves

Recommended EMG books

Selection of EMG text books used as a reference in this booklet

	<p>1) J.V. Basmajian Biofeedback <i>Principles and Practice for Clinicians.</i> Williams Wilkins, Baltimore 1989 ISBN 0-683-00357-7</p>		<p>7) S. Kumar; A. Mital Electromyography in Ergonomics Taylor&Francis, London 1996 ISBN 0-7484-0130-X</p>
	<p>2) J.V. Basmajian; C.J. De Luca Muscles Alive <i>Their Function Revealed by Electromyography.</i> Williams Wilkins, Baltimore 1985 ISBN 0-683-00414-X</p>		<p>8) J. Perry Gait Analysis <i>Normal and Pathological Function.</i> Slack Thorofare 1992 ISBN 1-55642-192-3</p>
	<p>3) C.J. De Luca; M. Knafitz Surface Electromyography: What's New? C.L.U.T., Torino 1992 ISBN -</p>		<p>9) C. Richardson et al. Therapeutic Exercises for Spinal Segmental Stabilization in Low Back Pain Churchill Livingstone, Edinburg 1999 ISBN 0-443-058024</p>
	<p>4) J.R.Cram; G. Kasman Introduction to Surface Electromyography Aspen 1998 ISBN 0-8342-0751-6</p>		<p>10) US Department of Health and Human Services Selected Topics in Surface Electromyography for Use in Occupational Settings: Expert Perspectives DHHS NIOSH Publications #91-100 1992</p>
	<p>5) R.M. Enoka Neuromechanical Basis of Kinesiology Human Kinetics, Champaign 1994 ISBN 0-87322-655-8</p>		<p>11) D.A. Winter Biomechanics and Motor Control of Human Movement John Wiley & Sons New York 1990 ISBN 0-683-00357-7</p>
	<p>6) G.S. Kasman et al. Clinical Applications in Surface Electromyography <i>Chronic Musculoskeletal Pain.</i> Aspen 1997 ISBN 0-8342-0752-4</p>		<p>12) D.A. Winter The Biomechanics and Motor Control of Human Gait: Normal, Elderly and Pathological Waterloo Biomechanics 1991 ISBN 0-88898-105-8</p>

EMG Guidelines, Societies, Search Links

The International Society of Electrophysiology and Kinesiology (ISEK)

Web Link: <http://isek.bu.edu/>

“The International Society of Electrophysiology and Kinesiology (ISEK) is a multidisciplinary organization composed of members from all over the world in health-related fields and basic science with a common desire to study human movement and the neuromuscular system”. The webpage contains important links, journals, congress dates and addresses for electromyographers. The very important “ISEK Standards of Reporting EMG Data” can be found under:

http://isek.bu.edu/publications/standards/emg_standards.html

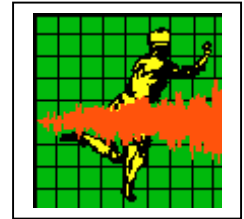

The European Recommendations for Surface Electromyography (SENIAM)

Web Link: <http://www.seniam.org/>

The SENIAM project (Surface Electromyography for the Non-Invasive Assessment of Muscles) is a European concerted action in the Biomedical Health and Research Program (BIOMED II) of the European Union. The SENIAM project developed important guidelines for EMG measurements. The results are published under:

Hermens H.J., Freriks B., Merletti R., Hägg G., Stegeman D.F., Blok J., Rau G., Disselhorst-Klug C. (1999) SENIAM 8: European Recommendations for Surface ElectroMyoGraphy, Roessingh Research and Development b.v., ISBN 90-75452-15-2.

Freriks B., Hermens H.J. (1999) SENIAM 9: European Recommendations for Surface ElectroMyoGraphy, results of the SENIAM project, Roessingh Research and Development b.v., 1999, ISBN 90-75452-14-4 (CD-rom).



Pubmed – free access to Medline

Web Link: <http://www.ncbi.nlm.nih.gov/entrez/query.fcgi>

“PubMed, a service of the National Library of Medicine, includes over 15 million citations for biomedical articles back to the 1950's. These citations are from MEDLINE and additional life science journals. PubMed includes links to many sites providing full text articles and other related resources”



Search engine Scholar Google

Web Link: <http://scholar.google.com/>

Extremely powerful search engine for (EMG-) articles and publications



Complete Line of Surface EMG and Sensor Systems

Since 1989, Noraxon has been manufacturing and distributing high-end surface electromyography (SEMG) and biomechanical sensor systems to research, sports medicine, ergonomics and clinical professionals worldwide. Our systems meet the technical requirements of highly acclaimed international research societies, like ISEK and Seniam and are CE or FDA approved.



Mobile Monitoring Concept and Connectivity

EMG, force, angle and other types of biomechanical sensors can be connected to a telemetry system. Data is then transmitted from the system directly to a computer or notebook. Hardware interface solutions and software export/import modules ensure complete communication capabilities to other measurement devices, such as movement analysis, isokinetics, force plates, footswitches, goniometers, etc.

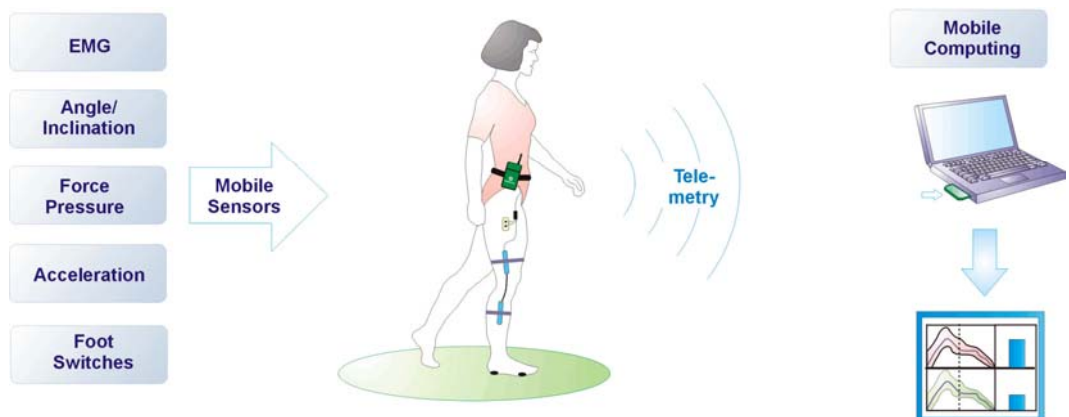

Real Time Monitoring of Muscle Activity and Performance

Noraxon's comprehensive data acquiring software features the most commonly used analysis routines of biomechanical, medical, occupational and sport science applications: from MVC Normalization to Wavelet Analysis, Onset Timing to ECG Removing. The option to quickly and easily configure report routines meets the professional need for a highly sophisticated software program.

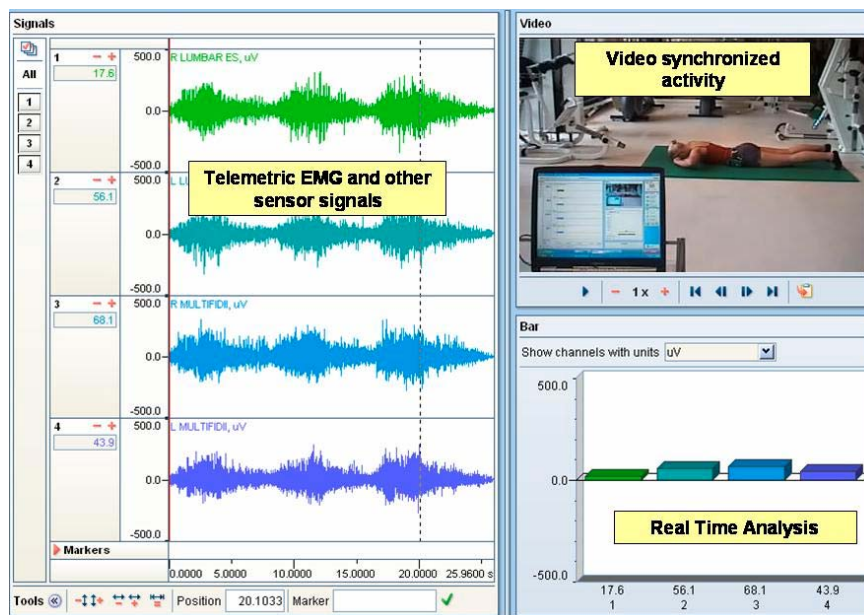

Numerous Ready-to-go Application Protocols

Noraxon's latest MyoResearch XP software features many protocols, such as Gait Analysis, Incontinence and Isokinetics, which perform immediate analysis with the push of a few buttons! From Postural Analysis to Gait Analysis, from Manual Muscle Function Tests to EMG Isokinetics, Noraxon's unique protocol system automatically guides you to meaningful results.

Choose the Market Leader!

With the investment in our high-quality, manufactured products and superior lifetime customer service, you can be assured you're in good hands. With more than 500 installations worldwide, Noraxon is the market leader for tethered and wireless multi-channel EMG & sensor systems.